

 **RITTER PEN**



 **RITTER CARES**

2021/2022

**„Stopping advertising
to save money
is like stopping your watch
to save time.“**

Henry Ford



RITTER PEN

RITTER PEN – more than 60 years competence MADE IN GERMANY!

Benefit from more than 60 years of experience in producing writing instruments for promotional needs. Ritter Pen was founded in 1928 and celebrated its 90th anniversary in 2018.

We have been manufacturing writing instruments of the highest quality for more than 60 years in our factory in Brensbach.

From the initial idea and the CAD drawing for our own tool making, to the plastic injection molding and printing - everything is done under one roof.

Production is based completely on our customers' wishes, i.e. manufacturing begins after receipt of the order for CE-compliant ball point pens .

This „Mix & Match“ modular system permits an almost limitless variety of models and colors for all writing instruments manufactured in Germany.

You will find a big variety of ball point pens in our Ritter Global line: manufactured either in our factory in China or by reputable specialists in the Far East.



IN JUST A FEW STEPS TO YOUR DESIRED BALL PEN

Whether online with our practical product configurator or in the classic way with our new full line catalog - you can design your own ball point pen in just a few steps:

- Choose your model
- Design your pen in your favourite color within the shown standard color range*. Let your creativity run free and choose the right color combination to match your logo.
*For special colour requests please contact us for layout proposals.
- The choice of refill is up to you - whether medium line width or soft refills for smooth, comfortable writing, and the option for black or blue ink. All „Made in Germany“ models are available with the types of refill of your choice.
- The logo upload function in our Penbuilder is the final step towards your perfect design - create the appropriate PDF file to get a first impression of your personal Ritter pen!



TABLE OF CONTENTS



































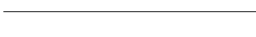







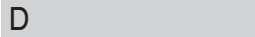

A

| | | |
|---|---------------------------|-----|
|  | Pencil 86020 | 22 |
|  | New Basic 19300 | 74 |
|  | Basic 19414 | 74 |
|  | Flip Transparent 30121 | 93 |
|  | Flip 20121 | 94 |
|  | Pencil 86022 | 22 |
|  | Trigger 00127 | 89 |
|  | Trigger Transparent 10127 | 90 |
|  | Twister 00040 | 71 |
|  | Pep SF 21250 | 52 |
|  | Top Spin Frozen 00083 | 92 |
|  | Top Spin Frozen SI 10083 | 92 |
|  | Flip Silver 50121 | 93 |
|  | Minissimo 20010 | 109 |

B

| | | |
|--|-----------------------------|----|
|  | Twister Frozen 00041 | 70 |
|  | Pep Frozen 11250 | 52 |
|  | Insider Transparent S 42300 | 67 |
|  | Insider ST 02310 | 68 |
|  | Ionos 31280 | 91 |
|  | Cetus Transparent 10109 | 94 |
|  | Cetus 20119 | 95 |

| | | |
|--|---------------------------|-----|
|  | All-Star SF 00071 | 51 |
|  | Peak STT 58700 | 61 |
|  | Peak 08700 | 65 |
|  | Peak ST 48700 | 65 |
|  | Ionos Transparent 41280 | 90 |
|  | Ionos Antibacterial 01280 | 25 |
|  | Clear Shiny 02020 | 53 |
|  | Clear ST 42023 | 55 |
|  | Clear 02000 | 55 |
|  | Insider Transparent 12300 | 69 |
|  | Cetus Silver 30119 | 95 |
|  | Insider Recycled 92302 | 12 |
|  | Fresh ST 55800 | 62 |
|  | Fresh 05800 | 63 |
|  | Classic 01711 | 75 |
|  | Insider STM 02312 | 68 |
|  | Diva 08198 | 72 |
| C | | |
|  | All-Star Frozen 10070 | 51 |
|  | Glory Transparent 10123 | 88 |
|  | Glory 00123 | 89 |
|  | NOTES TO GO 69.7604 | 108 |
|  | Clear Frozen 12000 | 56 |

| | | | | | |
|---|-----------------------------|----|--|--------------------------|----|
|  | Ionos Soft 01281 | 91 |  | Clear Silver 52000 | 54 |
|  | Clear Transparent 12020 | 58 |  | Crest Frozen 15900 | 49 |
|  | Clear Transparent S 42025 | 58 |  | All-Star Silver 50070 | 50 |
|  | Insider Transparent M 12302 | 69 |  | Clear Gold 52001 | 57 |
|  | All-Star Frozen SI 30070 | 50 |  | Bio-Mix 90250 | 19 |
|  | Fresh Transparent 15800 | 61 |  | Bonita 02250 | 60 |
|  | Classic Transparent 11711 | 75 |  | Havana 00118 | 86 |
|  | Fresh Antibacterial 05802 | 25 |  | Havana Transparent 10118 | 87 |
|  | Organic 90112 | 17 |  | Glossy 00086 | 87 |
|  | Crest 05900 | 48 |  | Glossy Transparent 10086 | 88 |
|  | Crest ST 55900 | 49 |  | Bio-Star 90071 | 17 |
|  | Combi 20124 | 77 |  | Atmos 08300 | 44 |
|  | Bio-Insider 92310 | 16 |  | Crest M 05902 | 47 |
|  | Clear Frozen SI 42000 | 56 |  | Plant 90080 | 11 |
|  | Diva Transparent 18198 | 72 |  | Bonita Transparent 12250 | 60 |
|  | Clear Silver F 32000 | 54 |  | Bio-Pen 92000 | 18 |
|  | Clear Frozen G 42001 | 57 |  | Atmos Frozen 18300 | 43 |
|  | Crest Recycled 95900 | 13 |  | Bubble Transparent 14400 | 71 |
| D | | |  | Spring Grippy 08138 | 78 |
|  | Soft Clear Frozen 12100 | 59 |  | Spring SP 08036 | 79 |
|  | Carton 70250 | 20 |  | Bio-Fresh 95800 | 18 |
|  | Carton II 72511 | 20 |  | Crest Recycled+ 95990 | 13 |
|  | Spring 08032 | 79 |  | Insider Soft ST 02311 | 66 |

| | | |
|--|--------------------------|-----|
|  | Strong 08200 | 80 |
|  | Tri-Star P 03532 | 36 |
|  | Strong Transparent 18200 | 80 |
|  | Crest CI 05910 | 48 |
|  | Combi Metall 60124 | 104 |
|  | Bio-Pen ID 92010 | 10 |
|  | Lift Transparent P 13810 | 28 |
|  | Club 08800 | 41 |
|  | Lift Recycled 93810 | 15 |

E

| | | |
|---|----------------------------------|-----|
|  | Insider Soft STM 02313 | 67 |
|  | Bio-Clear 92020 | 11 |
|  | Elegance 05300 | 45 |
|  | Exos P 07610 | 31 |
|  | Stratos Transparent Foil P 57910 | 83 |
|  | Club Transparent 18800 | 40 |
|  | Elegance Transparent 15300 | 45 |
|  | Fresh Soft ST 55801 | 62 |
|  | Bond Shiny 08910 | 42 |
|  | NOTES TO GO 69.7605 | 107 |
|  | NOTES TO GO 69.7606 | 108 |
|  | Satellite 07110 | 73 |
|  | Exos Recycled P 97610 | 14 |
|  | Bond 48900 | 43 |

| | | |
|--|--------------------|----|
|  | Spray Pen 00130 | 24 |
|  | Fresh Soft T 15801 | 63 |
|  | Bond Frozen 38900 | 42 |
|  | Empire 08401 | 46 |
|  | Helia 42200 | 59 |

F

| | | |
|--|--------------------------------|-----|
|  | Tri-Star 03530 | 34 |
|  | Lift 03800 | 27 |
|  | Booster Transparent Foil 42773 | 85 |
|  | Stratos 07900 | 38 |
|  | Club SI 48800 | 40 |
|  | Tri-Star Transparent 13530 | 33 |
|  | Tri-Star Transparent S 53530 | 34 |
|  | Glance 68700 | 102 |
|  | Stratos Camouflage 47910 | 82 |
|  | Club Transparent SI 38800 | 41 |
|  | Shine 65000 | 102 |
|  | Lift ST 23800 | 28 |
|  | Pin Pen 00060 | 76 |
|  | Stratos Transparent 17900 | 37 |
|  | Notes To Go + 69.7634 | 106 |
|  | Lift Soft P 03811 | 27 |
|  | Exos 07600 | 29 |
|  | Notes To Go 365 69.7633 | 107 |

| | | |
|---|-------------------------|----|
|  | Exos Transparent 17600 | 32 |
|  | Exos M 07602 | 30 |
|  | Tri-Star Soft STP 43531 | 35 |
|  | Tri-Star Soft 03531 | 35 |
|  | Club Silver 28800 | 39 |
|  | Knight 01464 | 73 |

G

| | | |
|---|------------------------------|-----|
|  | Exos Recycled 97600 | 14 |
|  | ALGO-PEN 97500 | 9 |
|  | Capri 69800 | 101 |
|  | Diva Foil 58198 | 84 |
|  | Touchpen 67500 | 103 |
|  | Capri Soft 69910 | 101 |
|  | Empire 18400 | 46 |
|  | Stratos Transparent SI 37901 | 38 |
|  | Minissimo Set 20010-06 | 109 |
|  | Exos Soft P 07611 | 32 |
|  | Triangle 68900 | 105 |
|  | Steel 68000 | 103 |
|  | Tri-Star Soft ST 43533 | 36 |
|  | Squarepen 61500 | 104 |
|  | Timber 82600 | 21 |
|  | Pin Pen SP 00066 | 77 |
|  | Exos Soft 07601 | 30 |

| | | |
|--|---------------------------|-----|
|  | Lift Soft 03801 | 26 |
|  | Exos Soft M 07603 | 31 |
|  | Noble 61200 | 99 |
|  | Bubble Foil 54400 | 84 |
|  | Noble Rollerball 61200.03 | 100 |

H

| | | |
|--|-----------------------------|-----|
|  | Exos Foil 57600 | 83 |
|  | Fortuna 61000 | 97 |
|  | Fortuna Rollerball 61000.03 | 97 |
|  | Triangle Set 68900 | 105 |
|  | Noble Set 61200 | 100 |
|  | Fortuna Set 61000/-20 | 98 |
|  | Pax 61110 | 98 |
|  | Triton 61310/-20 | 96 |



FINDING NEW WAYS

Ritter Pen's focus is sustainability.

In addition to many ecological measures within the production process, like using green electricity and LED technology, we make use of plastic waste and sprues for our in house recycling : means saving of waste and safeguarding of resources, for a better ecological balance.

We work constantly on increasing the Ecoline with products, made of new, environmental friendly raw materials. Using these bio-based plastics has result in reducing use of conventional plastics and saving resources:

- The new revolutionary, bio based material, consisting of seaweed and PLA for our **ALGO-PEN®** – is not only saving resources, but also helps to preserve sea biodiversity. It contains 20 % Sargassum : „born in the ocean“.
- The first Ritter Cares Biomaterial, based on cellulose acetate, is completely biodegradable and certified according to DIN EN 13432: 2000-12. The next generation of this material is available now also in colour : **BIO-PEN ID**
- **PLA** is a bio-based material that is obtained from natural raw materials, and also available in colours: **PLANT**
- The next generation in postconsumer recycled material and the perfect way to make use of waste : the rebirth of former shelf parts from **dm**-stores in our new **LIFT RECYCLED**, made of postconsumer recycled Polycarbonate.
- Our post consumer recycled ABS plastic is made of recycled household appliances. The use of this recyclate saves approx. 80% energy compared to the use of conventional plastics : **CREST RECYCLED**
- **ULTRA RECYCLED** large capacity refill is made of 95 % postconsumer recycled Polypropylen from packing waste. This means 80 % less environmental impact and 75 % less CO2 emissions.

The development and processing of recycled and natural materials is a sustainable step towards the future : **For the environment**



RAW MATERIAL ALGAE

ALGO-PEN® 97500



Made in Germany



Raw material out of the ocean - consisting of 20% brown algae and PLA



New trend-color ALGO, pushers optionally available in different colors, made of ABS plastic



Document proof, swiss made - large capacity Ultra Recycled refill, writing length: approx. 6.000 m



DIN-certified organic material

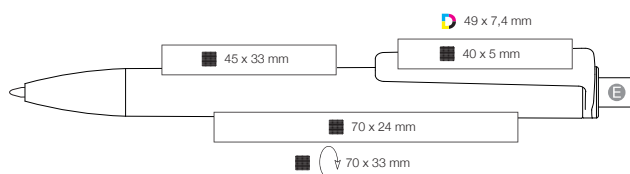

**NEW
2021**

BIO-PEN ID

SUSTAINABLE IDEAS IN COLOR

BIO-PEN ID 92010

Made in Germany



NEW
2021



Barrel and clip made of renewable, bio-based material cellulose acetate



Bestseller of our ECO-LINE now available in new colors, special colors on request



Document proof, swiss made - x-20 Jogger refill, writing length: approx. 2.000 m

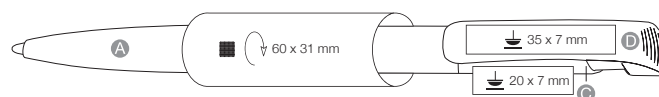

PLANT 90080

Made in Germany

- 90% Bio-based plastic PLA
- ! Made from naturally renewable raw material
- Document proof, swiss made - x-20 Jogger refill, writing length: approx. 2.000 m

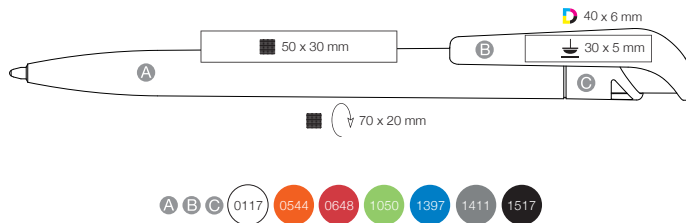

BIO-CLEAR 92020

Made in Germany

- 75% Barrel and clip made of renewable, bio-based material cellulose acetate
- ! Upper part made of ABS plastic
- Document proof, swiss made - Jumbo Marathon refill, writing length: approx. 2.500 m

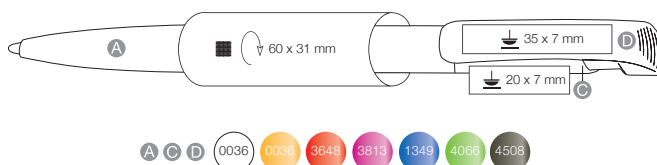

PRE-CONSUMER & POST-CONSUMER



FOR A BETTER FUTURE

INSIDER RECYCLED 92302

Made in Germany



Barrel is made of pre-consumer recycled plastic:
100 % regrind from our own production



Black barrel, colored clip and pusher



Document proof, swiss made - x-20 Jogger refill,
writing length: approx. 2.000 m

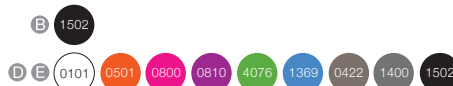
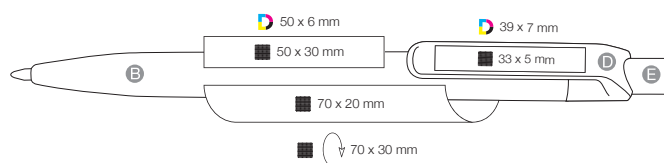

CREST RECYCLED+ 95990



Made in Germany



Post-consumer recycled plastic, which is extracted and processed from old plastic parts



Available in black and grey - pushers optionally available in different colors, made of ABS plastic



Document proof, swiss made - large capacity Ultra Recycled refill, writing length: approx. 6.000 m

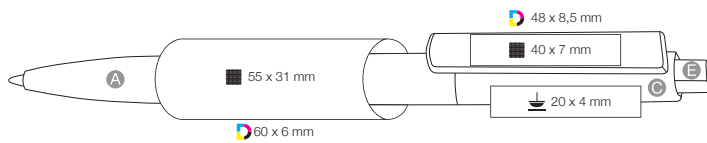

CREST RECYCLED 95900



Made in Germany



Post-consumer recycled plastic, which is extracted and processed from old plastic parts



Available in black and grey - pushers optionally available in different colors made of ABS plastic



Document proof, swiss made - x-20 Jogger Soft refill, writing length: approx. 1.400 m

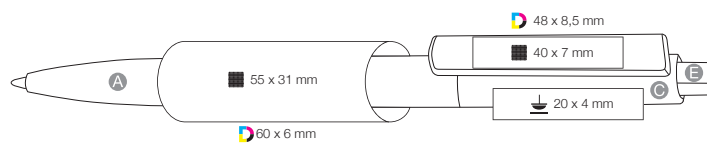

Jogger Soft

EXOS RECYCLED 97600

Made in Germany



Post-consumer recycled plastic, which is extracted and processed from old plastic parts



Available in black and grey - pushers optionally available in different colors, made of ABS plastic



Document proof, swiss made - large capacity Ultra Recycled refill, writing length: approx. 6.000 m

NEW 2021

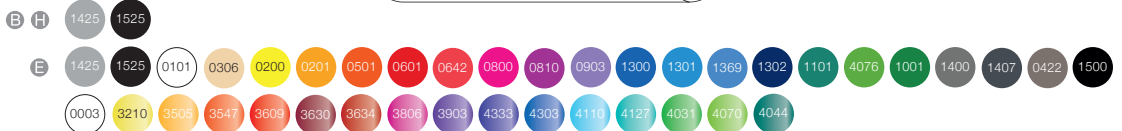
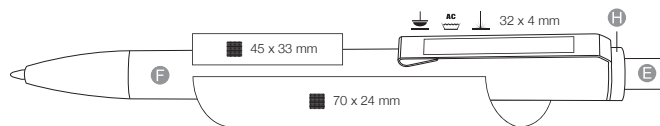

EXOS RECYCLED P 97610

Made in Germany



Post-consumer recycled plastic, which is extracted and processed from old plastic parts



Available in black and grey - pushers optionally available in different colors, made of ABS plastic



Document proof, swiss made - large capacity Ultra Recycled refill, writing length: approx. 6.000 m

NEW 2021

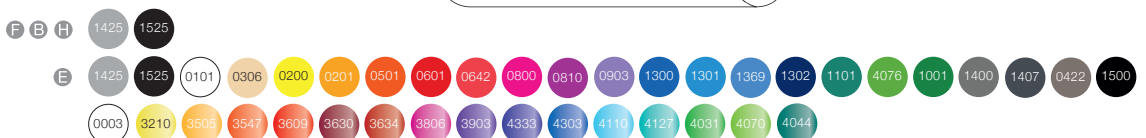
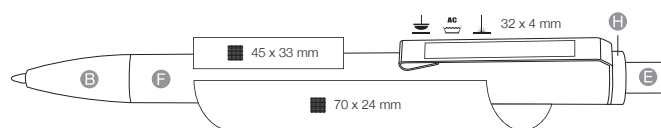

LIFT RECYCLED



RECYCLED
POLYCARBONAT

LIFT RECYCLED 93810



Made in Germany



Made from recycled polycarbonate - post-consumer recycled plastic, recovered from old dividers of the dm-stores



In cooperation with "dm-drogerie markt"



Document proof, swiss made - large capacity Ultra Recycled refill, writing length: approx. 6.000 m

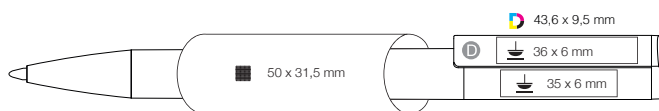

NEW
2021



POST-CONSUMER RECYCLED PP
Ultra Recycled



RENEWABLE

BIO-INSIDER 92310



Made in Germany



Jogger



Barrel and clip made of renewable, bio-based material cellulose acetate



Pusher made of ABS plastic - available in many colors



Document proof, swiss made - x-20 Jogger refill, writing length: approx. 2.000 m



DIN-certified organic material

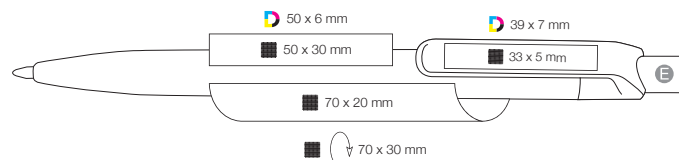

- Barrel and clip made of renewable, bio-based material cellulose acetate
- Cover optionally available in different colors, made of ABS plastic
- Document proof, swiss made - x-20 Jogger refill, writing length: approx. 2.000 m
- DIN-certified organic material

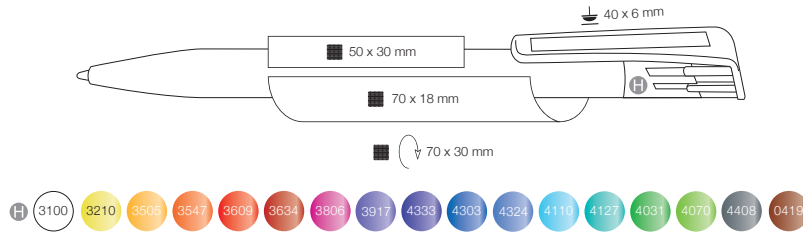

ORGANIC 90112

- Barrel and clip made of renewable, bio-based material cellulose acetate
- Pusher optionally available in different colors, made of ABS plastic
- Document proof, swiss made - x-20 Jogger refill, writing length: approx. 2.000 m
- DIN-certified organic material

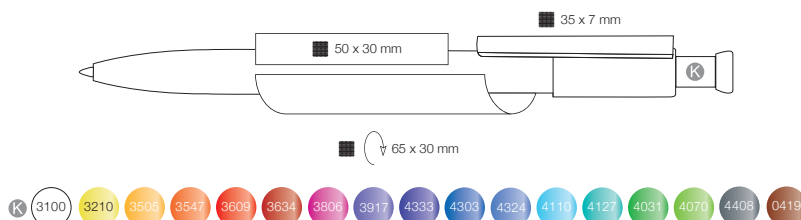

BIO-PEN 92000



Made in Germany



- Barrel and clip made of renewable, bio-based material cellulose acetate
- Upper part optionally available in different colors, made of ABS plastic
- Document proof, swiss made - x-20 Jogger refill, writing length: approx. 2.000 m
- DIN-certified organic material

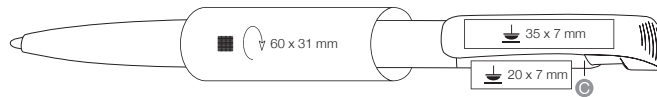

BIO-FRESH 95800

Made in Germany



- Barrel and clip made of renewable, bio-based material cellulose acetate
- Upper part optionally available in different colors, made of ABS plastic
- Digital print on clip possible
- Document proof, swiss made - x-20 Jogger Soft refill, writing length: approx. 1.400 m

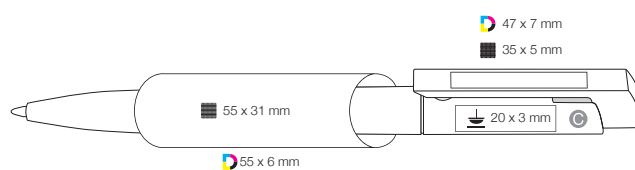





UNIQUE MATERIAL-MIX

BIO-MIX 90250

Made in Germany

-  Pusher and tip made of renewable, bio-based material cellulose acetate
-  Recycled cardboard barrel and wooden clip
-  Document proof, swiss made - x-20 Jogger refill, writing length: approx. 2.000 m

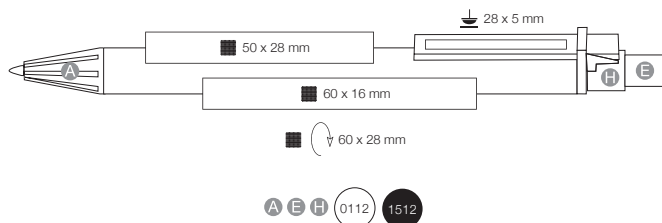

CARTON 70250

Made in Germany



Jogger



One of the first eco-pens,
barrel made of recycled cardboard, wooden clip



Document proof, swiss made - x-20 Jogger refill,
writing length: approx. 2.000 m

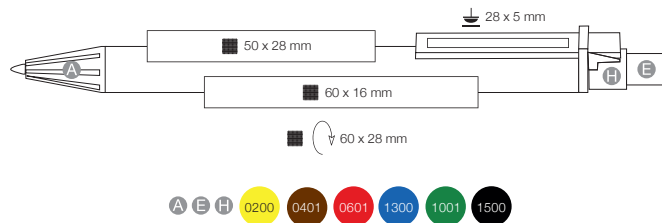

CARTON II 72511

Made in Germany



Jogger



One of the first eco-pens,
barrel made of recycled cardboard, wooden clip



Document proof, swiss made - x-20 Jogger refill,
writing length: approx. 2.000 m

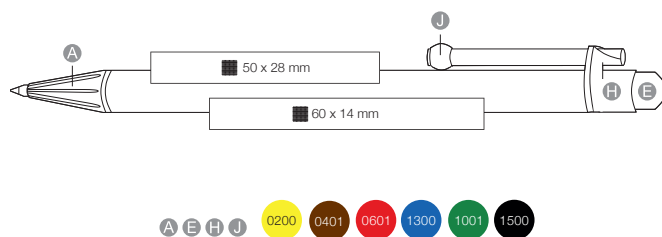

WOOD

OUT OF NATURE

TIMBER 82600

Ritter Global



Ballpen made of maple wood, pusher, tip and barrel made of nickel-plated brass



Blue writing, Budget large capacity refill, writing length: approx. 2.000 m

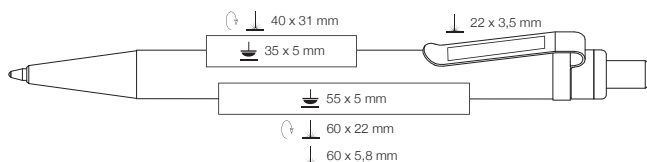

Budget

PENCIL 86020



- ! Graphite pencil, wood comes from certified forrests, color - natural
- ! Supplied sharpened and ready to write

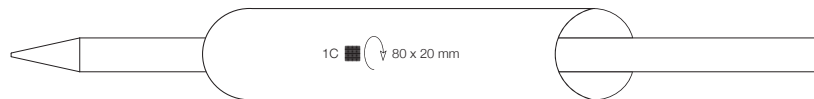

PENCIL 86022



- ! Graphite pencil made of black dyed limewood, wood comes from certified forrests, color - black
- ! Supplied sharpened and ready to write

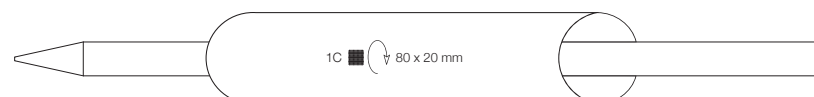

**„Everything that is against nature,
does not last.“**

Charles Darwin



TAKING CARE

SPRAY PEN 00130

 Ritter Global



● Mini Refill



Metal barrel in white, twist mechanism, refillable - capacity approx. 3,4 ml



Blue writing, Budget Mini refill, writing length: approx. 300 m

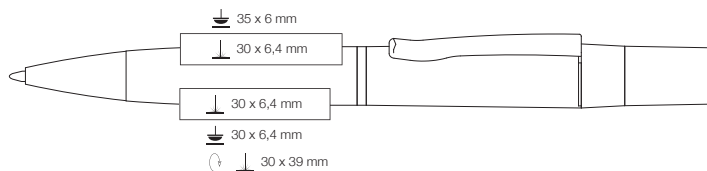

FRESH ANTIVIRAL 05802

Made in Germany

! Antibacterial and **antiviral** surface, tested and certified according to ISO 22196 and ISO 21702, effective against Covid-19

Document proof, swiss made - x-20 Jogger Soft refill, writing length: approx. 1.400 m

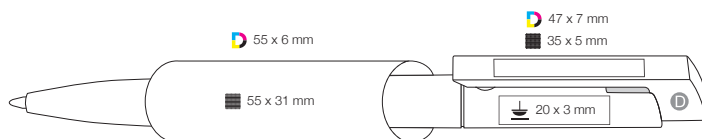

NEW
2021



IONOS ANTIBACTERIAL 01280

Ritter Global

! Antibacterial surface, tested and certified according to ISO 22196

Blue writing, Budget large capacity refill, writing length: approx. 1.400 m

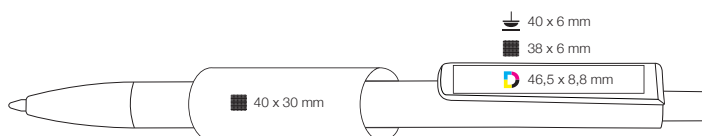

0101 1500



LIFT



LIFT ME UP

LIFT SOFT 03801

Made in Germany



Ultra
●
●



Twist mechanism, soft-touch surface and matt metal tip



Soft-touch surface: The print is protected due to the soft touch lacquering



Document proof, swiss made - large capacity Ultra refill, writing length: approx. 6.000 m

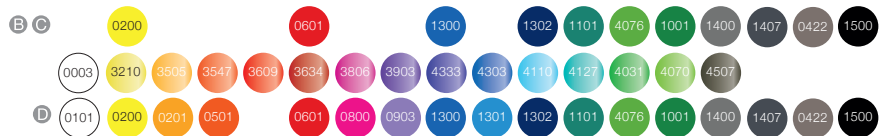

LIFT SOFT P 03811

Made in Germany

- ! Twist mechanism and soft-touch surface
- Soft-touch surface: The print is protected due to the soft touch lacquering
- Document proof, swiss made - large capacity Ultra refill, writing length: approx. 6.000 m

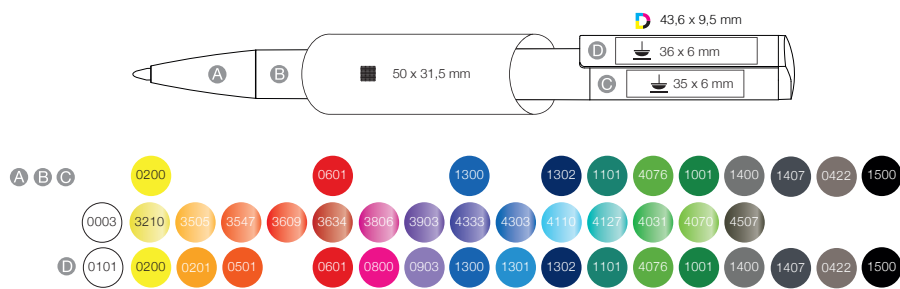

LIFT 03800

Made in Germany

- ! Twist mechanism, shiny metal tip
- Document proof, swiss made - large capacity Ultra refill, writing length: approx. 6.000 m

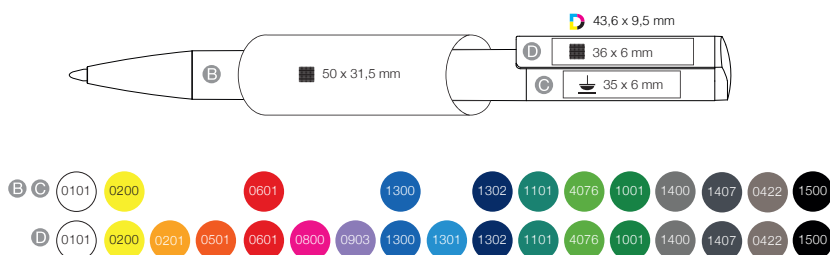

LIFT TRANSPARENT P 13810

Made in Germany



Transparent colors with twist mechanism, unique magnifying glass effect



Document proof, swiss made - large capacity Ultra refill, writing length: approx. 6.000 m

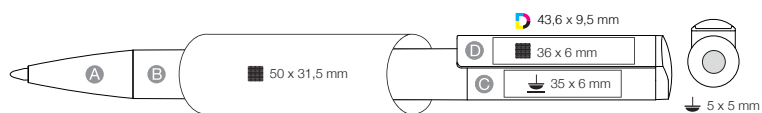

LIFT ST 23800

Made in Germany



Ultra



Shiny barrel with transparent clip, twist mechanism



Document proof, swiss made - large capacity Ultra refill, writing length: approx. 6.000 m



EXOS

TIMELESS DESIGN

EXOS 07600

Made in Germany

- ! Shiny barrel, metal tip and clip
- Document proof, swiss made - large capacity Ultra Soft refill, writing length: approx. 4.000 m

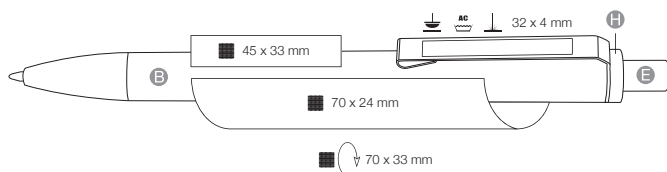

Ultra Soft

EXOS M 07602

Made in Germany



! Metal tip and clip, metalized pusher

Document proof, swiss made - large capacity Ultra Soft refill, writing length: approx. 4.000 m

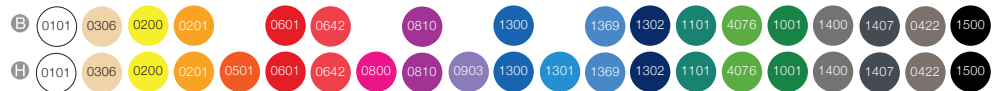
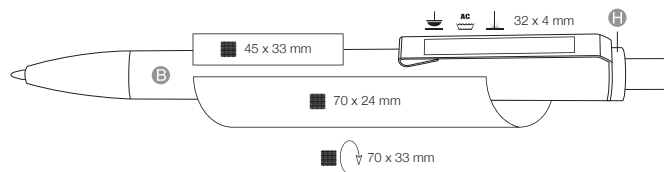

EXOS SOFT 07601

Made in Germany



! Soft-Touch surface, metal tip and clip

Soft-touch surface: The print is protected due to the soft touch lacquering

Document proof, swiss made - large capacity Ultra Soft refill, writing length: approx. 4.000 m

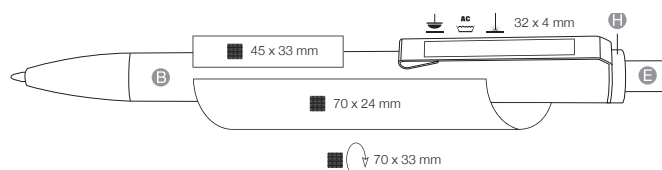

EXOS SOFT M 07603

Made in Germany

- ! Metal tip and clip, metalized pusher
- Soft Touch Soft-touch surface: The print is protected due to the soft touch lacquering
- Document proof, swiss made - large capacity Ultra Soft refill, writing length: approx. 4.000 m

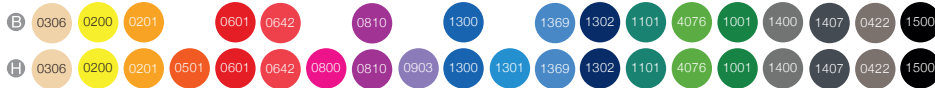
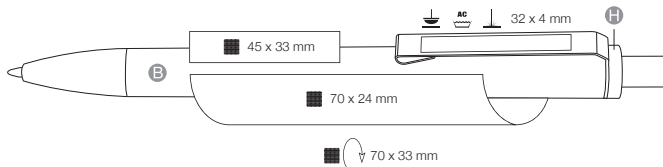

EXOS P 07610

Made in Germany

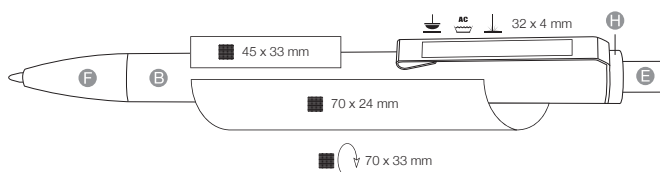

- ! Shiny colors, sturdy metal clip
- Document proof, swiss made - large capacity Ultra Soft refill, writing length: approx. 4.000 m



EXOS SOFT P 07611

Made in Germany



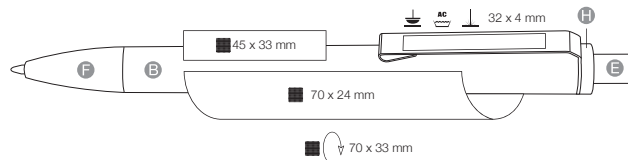

- 
Sturdy metal clip, soft-touch surface
- 
Soft-touch surface: The print is protected due to the soft touch lacquering
- 
Document proof, swiss made - large capacity Ultra Soft refill, writing length: approx. 4.000 m



EXOS TRANSPARENT 17600

Made in Germany



- 
Metal tip and clip, transparent colors
- 
Document proof, swiss made - large capacity Ultra Soft refill, writing length: approx. 4.000 m

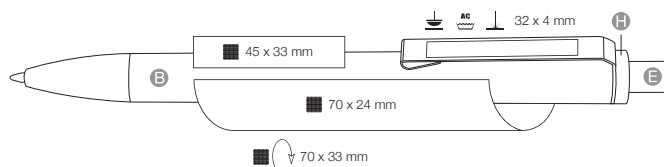

TRI-STAR

TIME
TO WRITE

TRI-STAR TRANSPARENT 13530

Made in Germany

- ! Triangular shaped barrel for best writing comfort, metal tip, transparent colors
- Document proof, swiss made - large capacity Ultra refill, writing length: approx. 6.000 m

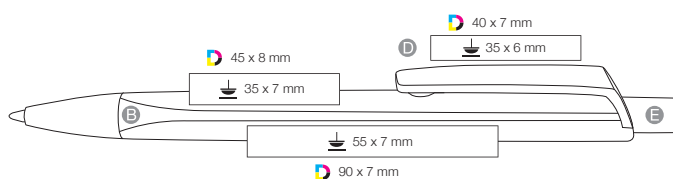

TRI-STAR TRANSPARENT S 53530

Made in Germany



Ultra



Triangular shaped barrel for best writing comfort, metal tip, transparent colors, solid white clip



Document proof, swiss made - x-20 Jogger refill, writing length: approx. 2.000 m

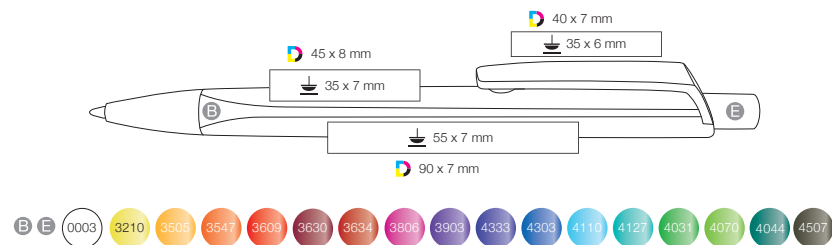

TRI-STAR 03530

Made in Germany



Ultra



Triangular shaped barrel for best writing comfort, metal tip, shiny surface



Document proof, swiss made - large capacity Ultra refill, writing length: approx. 6.000 m

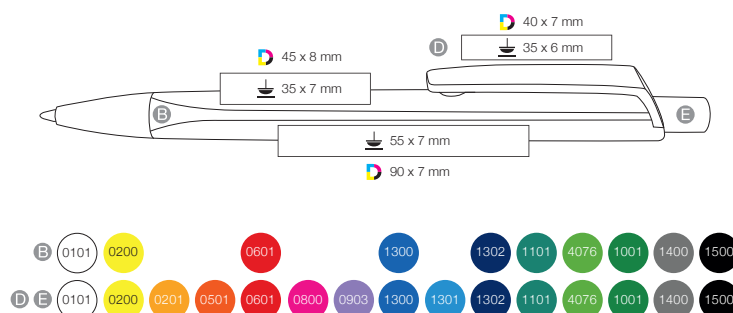

TRI-STAR SOFT STP 43531

Made in Germany



Triangular shaped barrel with soft-touch for best writing comfort



Transparent clip and pusher



Document proof, swiss made - large capacity Ultra refill, writing length: approx. 6.000 m

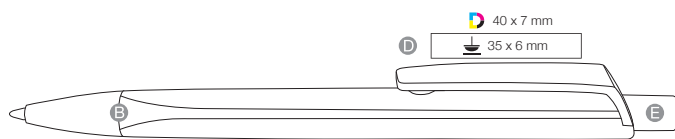

TRI-STAR SOFT P 03531

Made in Germany



Triangular shaped barrel with soft-touch for best writing comfort



Document proof, swiss made - large capacity Ultra refill, writing length: approx. 6.000 m

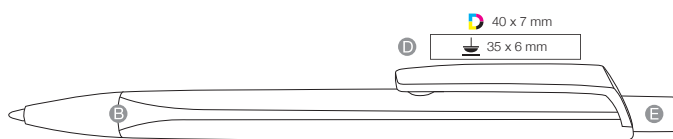

TRI-STAR SOFT ST 43533

Made in Germany



Ultra



Triangular shaped barrel with soft-touch for best writing comfort



Transparent clip and pusher



Document proof, swiss made - large capacity Ultra refill, writing length: approx. 6.000 m

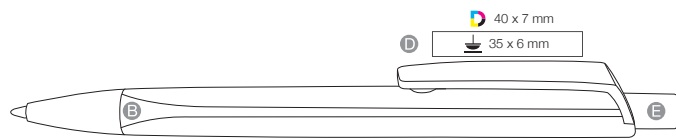

TRI-STAR P 03532

Made in Germany



Ultra



Triangular shaped barrel for best writing comfort, shiny surface



Document proof, swiss made - large capacity Ultra refill, writing length: approx. 6.000 m

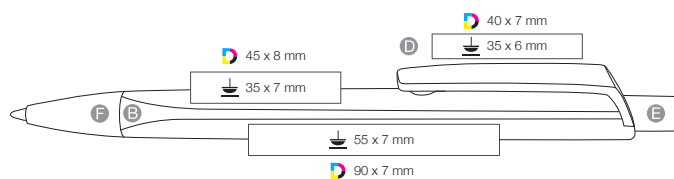

STRATOS

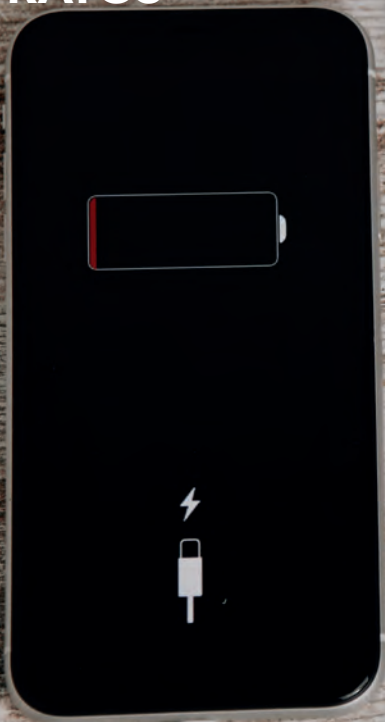

COUNT
ON IT

STRATOS TRANSPARENT 17900

Made in Germany



Transparent colors, metal tip



Document proof, swiss made - large capacity Ultra refill,
writing length: approx. 6.000 m

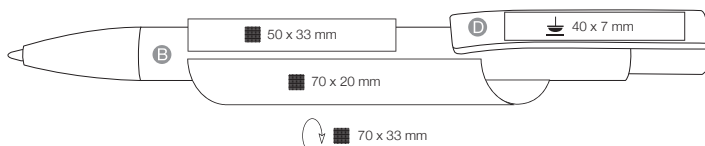

Ultra
●
●

STRATOS 07900

Made in Germany



Shiny surface, metal tip



Document proof, swiss made - large capacity Ultra refill, writing length: approx. 6.000 m

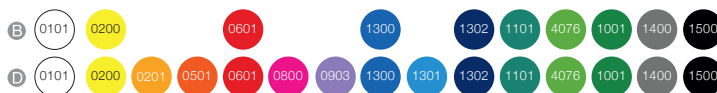
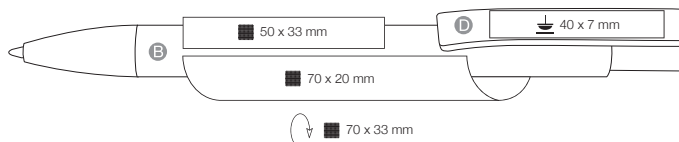

STRATOS TRANSPARENT SI 37901

Made in Germany



Transparent barrel, metal tip, silver lacquered clip



Document proof, swiss made - large capacity Ultra refill, writing length: approx. 6.000 m

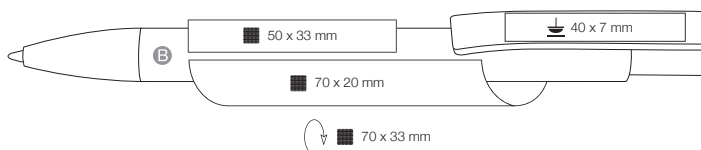

SOFT GRIP

ALWAYS
AT HAND

CLUB SILVER 28800

Made in Germany

! Soft grip for perfect writing comfort, stainless steel clip, silver lacquered

Document proof, swiss made - large capacity Ultra refill, writing length: approx. 6.000 m

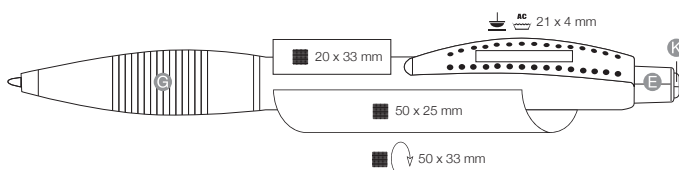

Ultra

CLUB SI 48800

Made in Germany



Marathon



Soft grip for perfect writing comfort, silver lacquered tip, stainless steel clip



Document proof, swiss made - Jumbo Marathon refill, writing length: approx. 2.500 m

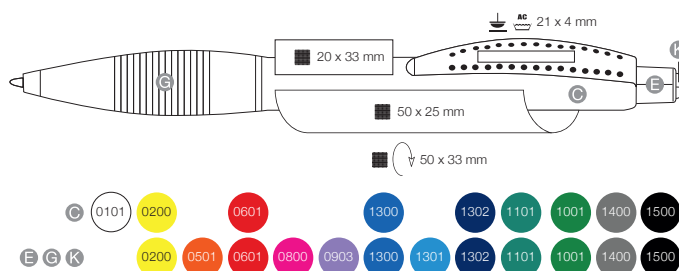

CLUB TRANSPARENT 18800

Made in Germany



Marathon



Soft grip for perfect writing comfort, transparent colors, stainless steel clip



Document proof, swiss made - Jumbo Marathon refill, writing length: approx. 2.500 m

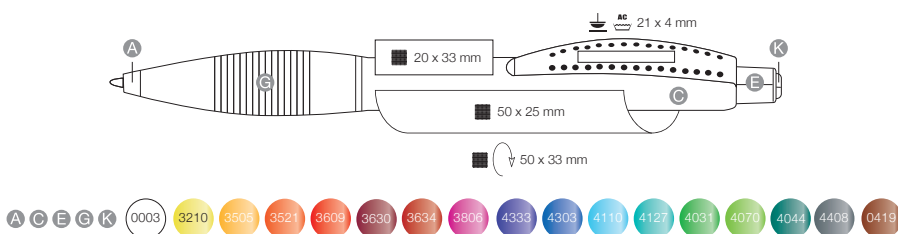

! Soft grip for perfect writing comfort, stainless steel clip

Document proof, swiss made - x-20 Jogger refill, writing length: approx. 2.000 m

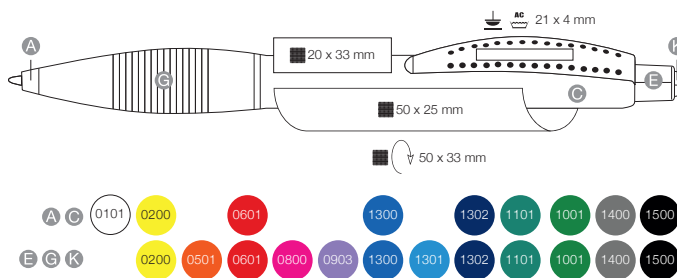

Jogger

CLUB TRANSPARENT SI 38800

! Soft grip for perfect writing comfort, silver lacquered clip, stainless steel clip

Document proof, swiss made - Jumbo Marathon refill, writing length: approx. 2.500 m

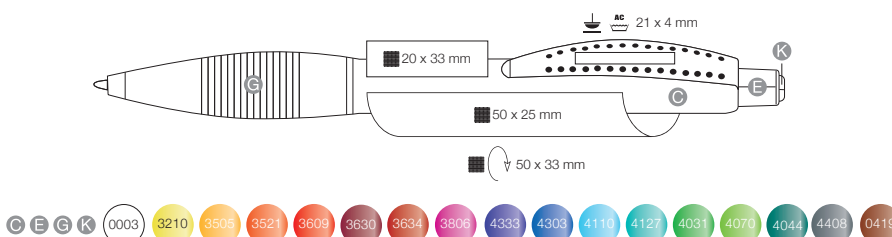

Marathon

BOND SHINY 08910

Made in Germany



Soft grip for perfect writing comfort, polished metal clip



Document proof, swiss made - Jumbo Marathon refill, writing length: approx. 2.500 m

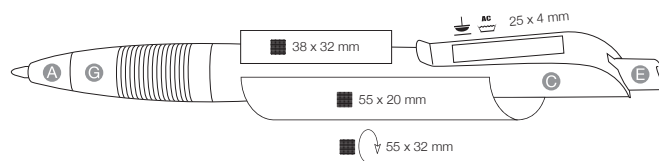

BOND FROZEN 38900

Made in Germany



Soft grip for perfect writing comfort, silver lacquered tip, stainless steel clip



Document proof, swiss made - Jumbo Marathon refill, writing length: approx. 2.500 m

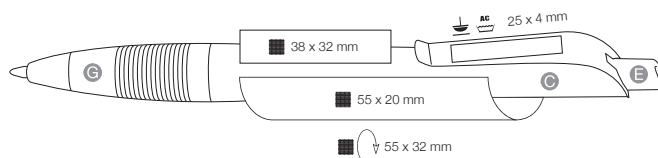

BOND 48900

Made in Germany

! Soft grip for perfect writing comfort, silver lacquered tip, stainless steel clip

Document proof, swiss made - Jumbo Marathon refill, writing length: approx. 2.500 m

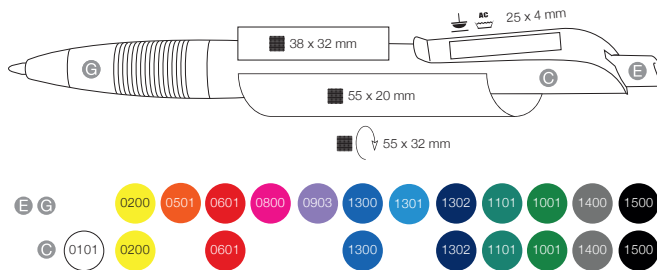

ATMOS FROZEN 18300

Made in Germany

! Three-sided soft grip for a perfect feel, produced in two-component injection process

Document proof, swiss made - Jumbo Marathon Soft refill, writing length: approx. 1.800 m

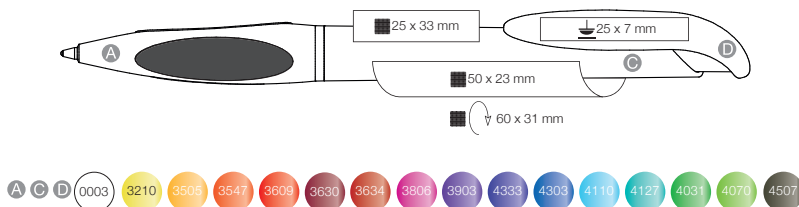

ATMOS 08300

Made in Germany



Three-sided soft grip for a perfect feel, produced in two-component injection process



Document proof, swiss made - Jumbo Marathon Soft refill, writing length: approx. 1.800 m

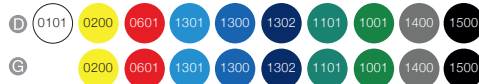
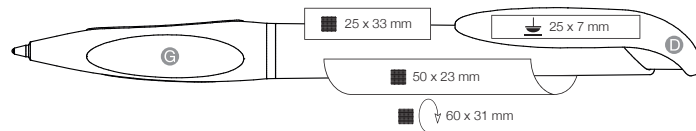

ATMOS 08300

Made in Germany



Three-sided soft grip for a perfect feel, produced in two-component injection process



Document proof, swiss made - Jumbo Marathon Soft refill, writing length: approx. 1.800 m

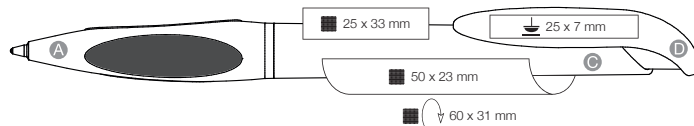

ELEGANCE TRANSPARENT 15300

Made in Germany

! Elegant steel clip, transparent colors

Document proof, swiss made - Jumbo Marathon Soft refill, writing length: approx. 1.800 m

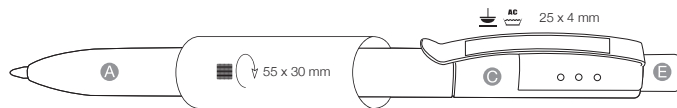

ELEGANCE 05300

Made in Germany

! Elegant steel clip, shiny surface

Document proof, swiss made - Jumbo Marathon Soft refill, writing length: approx. 1.800 m



EMPIRE 08401

Made in Germany



! Flexible, durable metal clip

Document proof, swiss made - x-20 Jogger refill, writing length: approx. 2.000 m

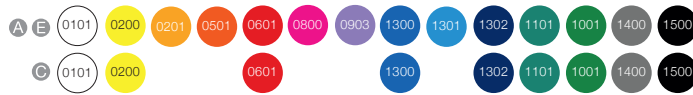
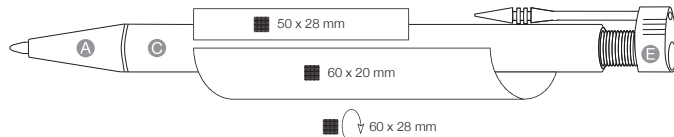

EMPIRE 18400

Made in Germany



! Flexible, durable metal clip

Document proof, swiss made - x-20 Jogger refill, writing length: approx. 2.000 m

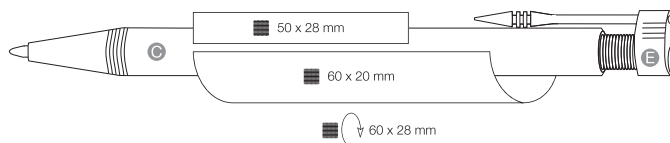

CREST

FORM AND FUNCTION

CREST M 05902

Made in Germany



Metalized pusher in triangular shape, matt barrel, shiny clip



Document proof, swiss made - x-20 Jogger Soft refill, writing length: approx. 1.400 m

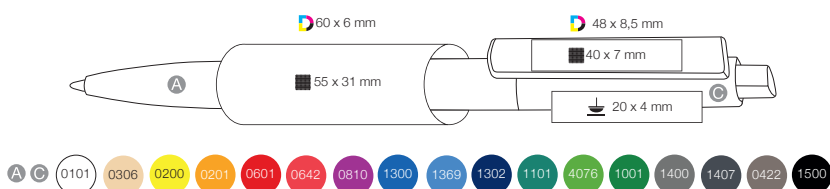

Jogger Soft

CREST CI 05910

Made in Germany



Jogger Soft

- ❗ CI-Clip – (approx. production time 5-6 weeks)
- ❗ Transparent pusher in triangular shape, matt barrel, shiny clip
- 📄 Document proof, swiss made - x-20 Jogger Soft refill, writing length: approx. 1.400 m

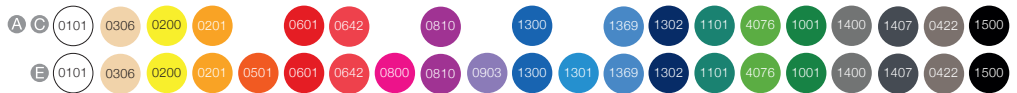
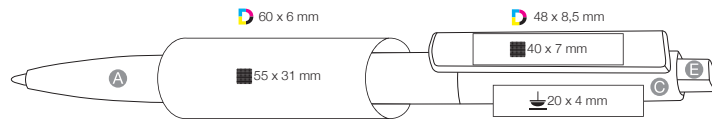

CREST 05900

Made in Germany



Jogger Soft

- ❗ Pusher in triangular shape, matt barrel, shiny clip and pusher
- 📄 Document proof, swiss made - x-20 Jogger Soft refill, writing length: approx. 1.400 m

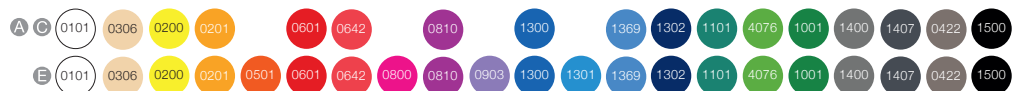
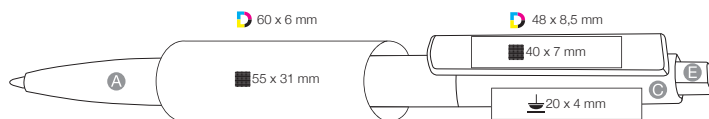

CREST FROZEN 15900

Made in Germany



Pusher in triangular shape, frosted barrel, transparent clip and pusher



Document proof, swiss made - Jumbo Marathon Soft refill, writing length: approx. 1.800 m

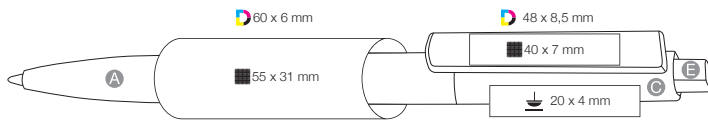

CREST ST 55900

Made in Germany



Transparent pusher in triangular shape, matt barrel, shiny clip



Document proof, swiss made - x-20 Jogger Soft refill, writing length: approx. 1.400 m

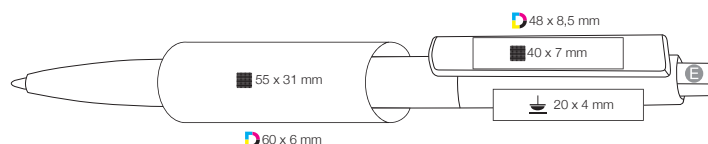

ALL-STAR FROZEN SI 30070

Made in Germany



Marathon



Frozen barrel and clip, silver lacquered cover



Document proof, swiss made - Jumbo Marathon refill, writing length: approx. 2.500 m

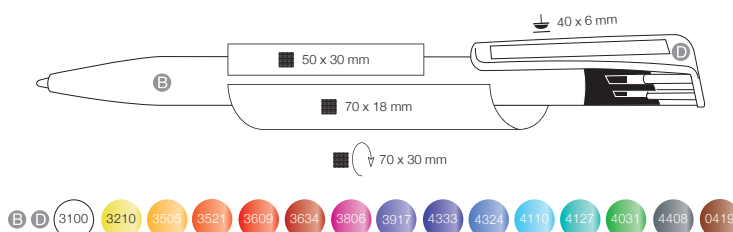

ALL-STAR SILVER 50070

Made in Germany



Jogger



Silver lacquered barrel and clip, cover in frozen colors



Document proof, swiss made - x-20 Jogger refill, writing length: approx. 2.000 m

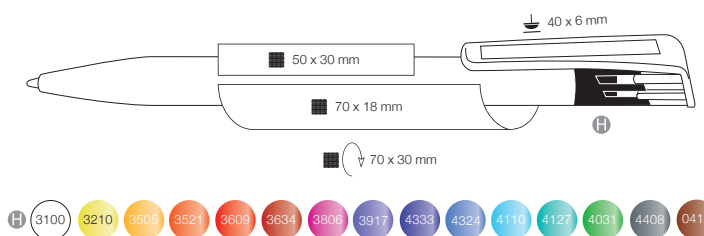

ALL-STAR SF 00071

Made in Germany



Solid colors, cover in frozen colors



Document proof, swiss made - x-20 Jogger refill,
writing length: approx. 2.000 m

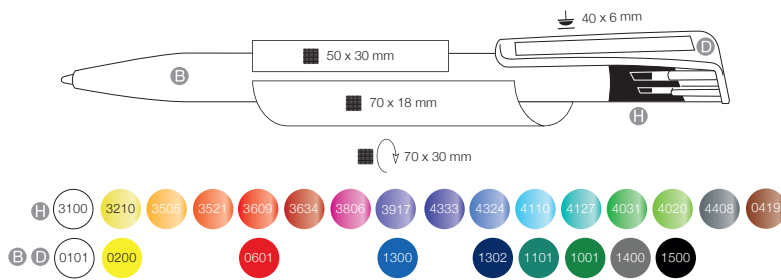

ALL-STAR FROZEN 10070

Made in Germany



Frozen colors



Document proof, swiss made - Jumbo Marathon refill,
writing length: approx. 2.500 m

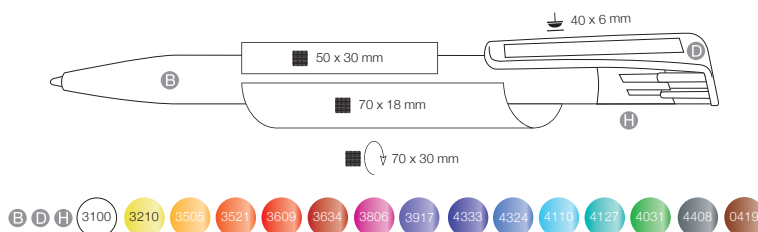

PEP SF 21250

Made in Germany



Twist mechanism, barrel in solid white, clip in frozen colors



Document proof, swiss made - x-20 Jogger refill, writing length: approx. 2.000 m

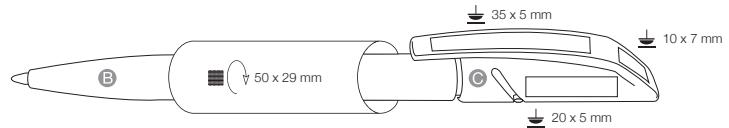

B 0101

C 3100 3210 3505 3521 3609 3634 3806 3917 4333 4324 4110 4127 4031 4408 0419

Jogger



PEP FROZEN 11250

Made in Germany



Twist mechanism, frozen colors



Document proof, swiss made - Jumbo Marathon refill, writing length: approx. 2.500 m

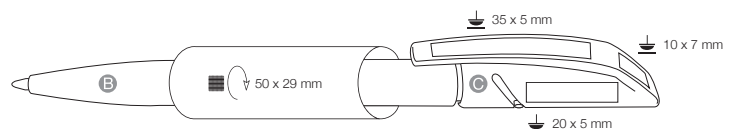

B C 3100 3210 3505 3521 3609 3634 3806 3917 4333 4324 4110 4127 4031 4408 0419

Marathon



CLEAR



CLEAR THING

CLEAR SHINY 02020

Made in Germany



Shiny surface, solid colors



Document proof, swiss made - x-20 Jogger refill, writing length: approx. 2.000 m

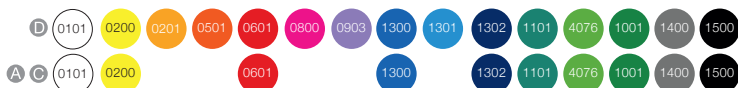
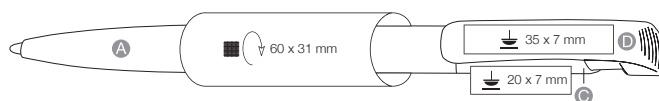

Jogger

CLEAR SILVER F 32000

Made in Germany



Jogger



Silver lacquered barrel, clip in frozen colors



Document proof, swiss made - x-20 Jogger refill, writing length: approx. 2.000 m



CLEAR SILVER 52000

Made in Germany



Jogger



Silver lacquered



Document proof, swiss made - x-20 Jogger refill, writing length: approx. 2.000 m



CLEAR ST 42023

Made in Germany

! Shiny surface, transparent clip

Document proof, swiss made - x-20 Jogger refill, writing length: approx. 2.000 m



CLEAR 02000

Made in Germany

! Solid colors, matt surface

Document proof, swiss made - x-20 Jogger refill, writing length: approx. 2.000 m

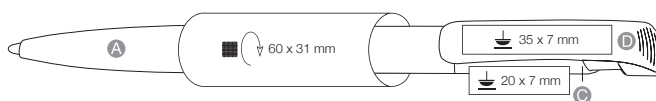

CLEAR FROZEN SI 42000

Made in Germany



Marathon



Frozen barrel and upper part, silver lacquered clip



Document proof, swiss made - Jumbo Marathon refill, writing length: approx. 2.500 m

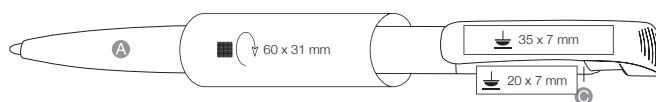

CLEAR FROZEN 12000

Made in Germany



Marathon



Frozen colors



Document proof, swiss made - Jumbo Marathon refill, writing length: approx. 2.500 m

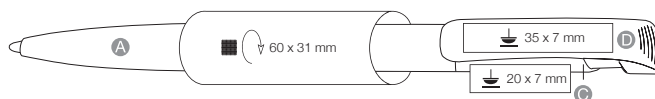

CLEAR GOLD 52001

Made in Germany

! Gold lacquered

Document proof, swiss made - x-20 Jogger refill,
writing length: approx. 2.000 m

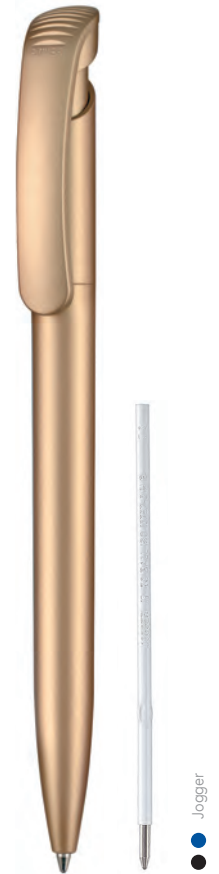
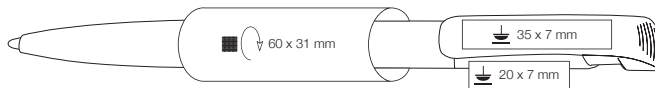

Jogger

CLEAR FROZEN G 42001

Made in Germany

! Gold lacquered clip, frosted barrel and upper part

Document proof, swiss made - Jumbo Marathon refill,
writing length: approx. 2.500 m

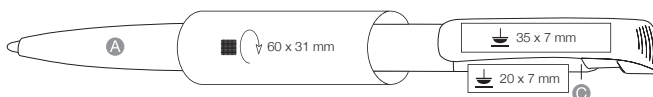

Marathon



CLEAR TRANSPARENT 12020

Made in Germany



Marathon



! Transparent colors



Document proof, swiss made - Jumbo Marathon refill, writing length: approx. 2.500 m

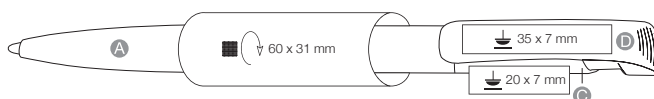

CLEAR TRANSPARENT S 42025

Made in Germany



Marathon



! Transparent barrel and upper part, solid white clip



Document proof, swiss made - Jumbo Marathon refill, writing length: approx. 2.500 m

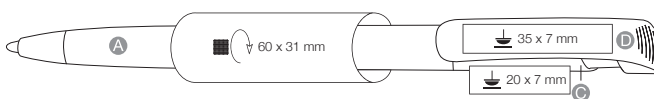

SOFT CLEAR FROZEN 12100

Made in Germany

! Frosted colors, soft grip for comfortable writing

Document proof, swiss made - Jumbo Marathon refill, writing length: approx. 2.500 m

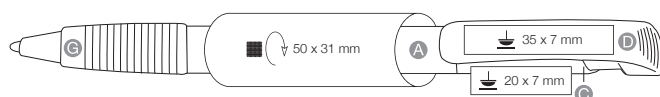

HELIA 42200

Made in Germany

! Metal tip and silver lacquered clip, frosted barrel and upper part

Document proof, swiss made - Jumbo Marathon refill, writing length: approx. 2.500 m

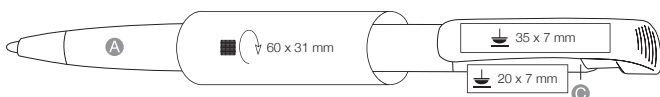

BONITA 02250

Made in Germany



Marathon



Metalized tip, shiny surface



Document proof, swiss made - Jumbo Marathon refill, writing length: approx. 2.500 m

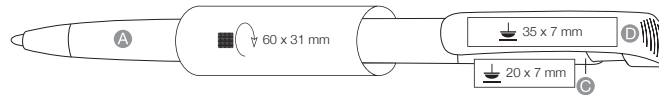

BONITA TRANSPARENT 12250

Made in Germany



Marathon



Metalized tip, transparent colors



Document proof, swiss made - Jumbo Marathon refill, writing length: approx. 2.500 m

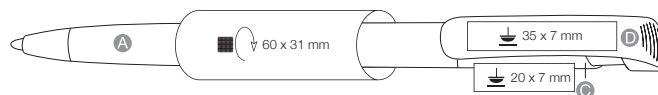

FRESH

FRESH IDEAS

FRESH TRANSPARENT 15800

Made in Germany



Transparent colors



Document proof, swiss made - Jumbo Marathon Soft refill, writing length: approx. 1.800 m

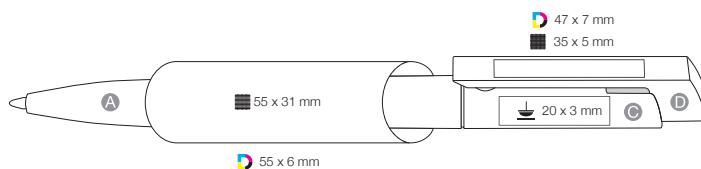

- A
- C
- D
- 0003
- 3210
- 3505
- 3547
- 3609
- 3634
- 3630
- 3806
- 3903
- 4333
- 4303
- 4110
- 4127
- 4031
- 4070
- 4044
- 4507



Marathon Soft

FRESH ST 55800

Made in Germany



Jogger Soft



Solid white barrel and upper part, transparent clip



Document proof, swiss made - x-20 Jogger Soft refill, writing length: approx. 1.400 m

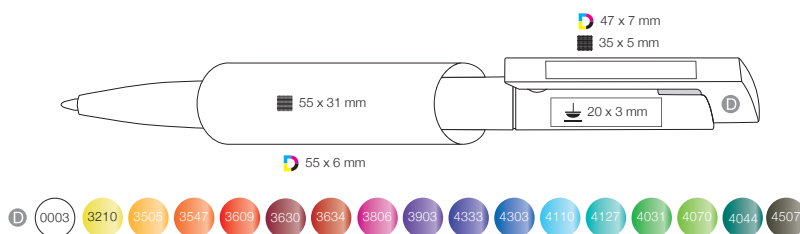

FRESH SOFT ST 55801

Made in Germany



Jogger Soft



Soft-touch surface: The print is protected due to the soft touch lacquering



Document proof, swiss made - x-20 Jogger Soft refill, writing length: approx. 1.400 m

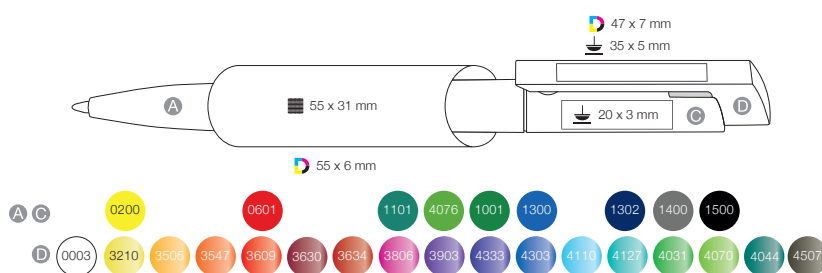

FRESH 05800

Made in Germany

 Shiny surface, solid colors

 Document proof, swiss made - x-20 Jogger Soft refill, writing length: approx. 1.400 m

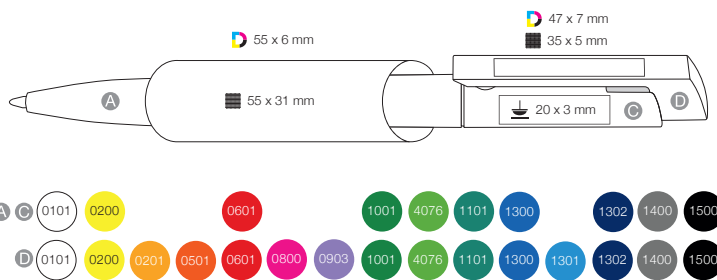

FRESH SOFT T 15801

Made in Germany

 Soft-touch surface: The print is protected due to the soft touch lacquering

 Document proof, swiss made - Jumbo Marathon Soft refill, writing length: approx. 1.800 m

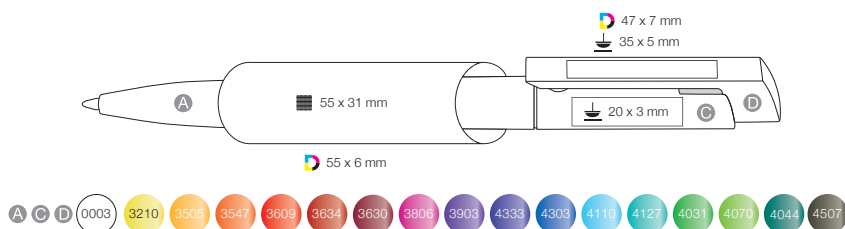

PEAK

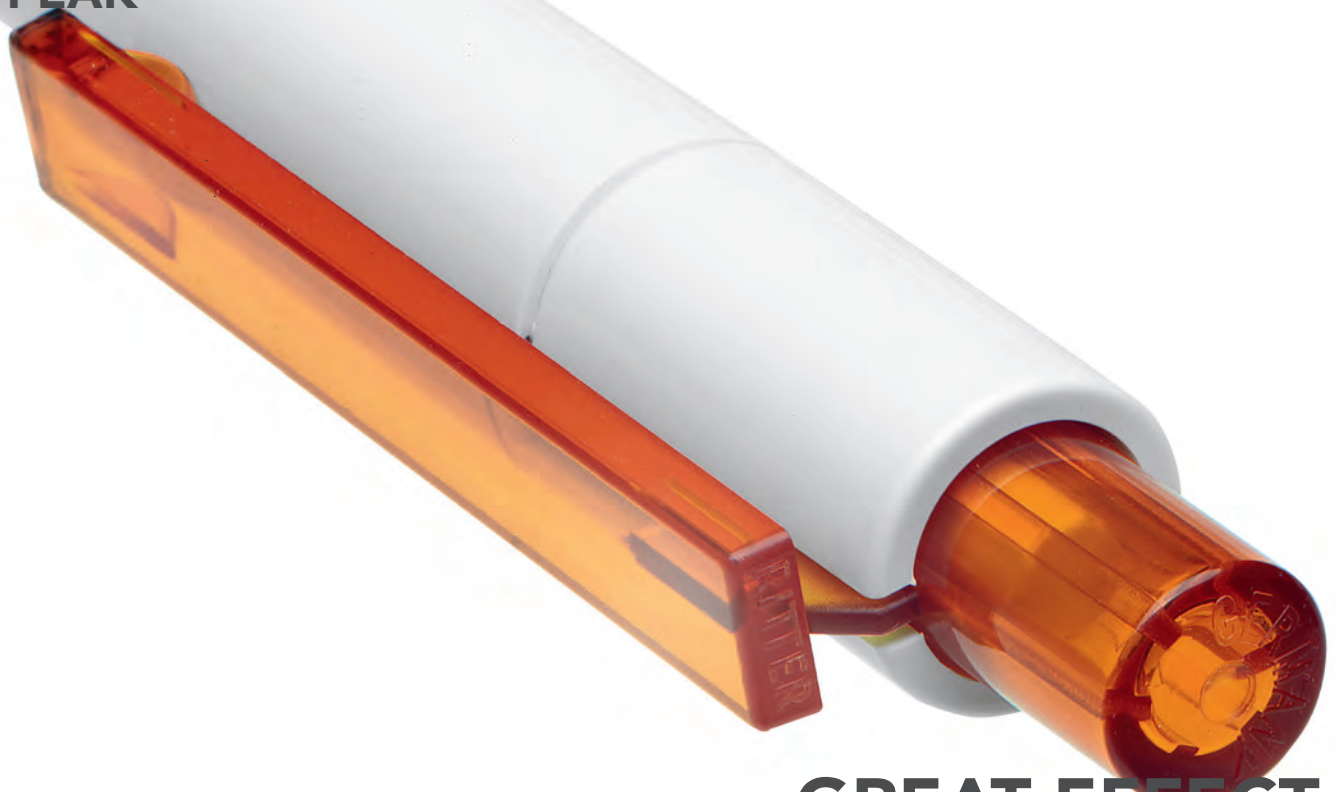

GREAT EFFECT

PEAK STT 58700

Made in Germany



Jogger Soft



Shiny barrel in solid white, transparent clip



Document proof, swiss made - x-20 Jogger Soft refill,
writing length: approx. 1.400 m

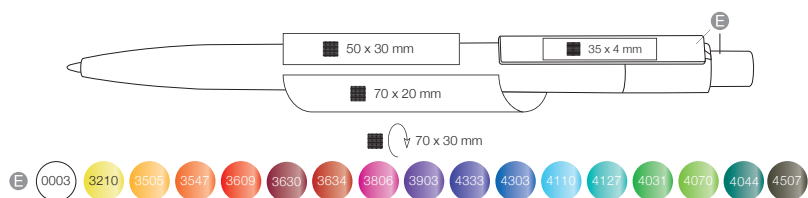

PEAK 08700

Made in Germany

! Shiny surface, solid colors

Document proof, swiss made - x-20 Jogger Soft refill, writing length: approx. 1.400 m

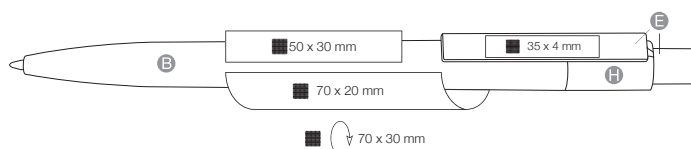

PEAK ST 48700

Made in Germany

! Shiny barrel in solid white, transparent cover

Document proof, swiss made - x-20 Jogger Soft refill, writing length: approx. 1.400 m

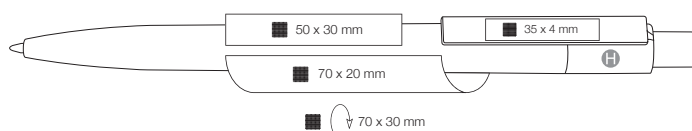



THERE IS MORE INSIDE

INSIDER SOFT ST 02311

Made in Germany



Jogger



Solid color barrel, transparent clip und pusher



Soft-touch surface: The print is protected due to the soft touch lacquering



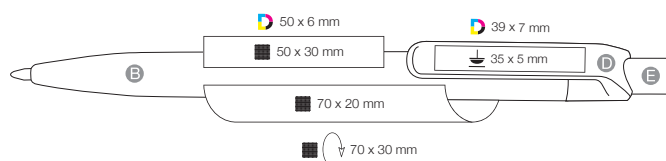

Document proof, swiss made - x-20 Jogger refill, writing length: approx. 2.000 m



INSIDER SOFT STM 02313

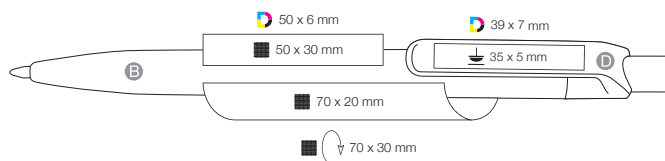

Made in Germany

-  Barrel solid colors, transparent clip , metalized pusher
-  Soft-touch surface: The print is protected due to the soft touch lacquering
-  Document proof, swiss made - x-20 Jogger refill, writing length: approx. 2.000 m



INSIDER TRANSPARENT S 42300

Made in Germany

-  Transparent barrel with prism optics, solid white clip
-  Document proof, swiss made - x-20 Jogger refill, writing length: approx. 2.000 m

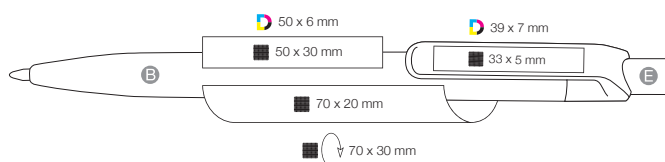



Solid white barrel, metalized pusher, transparent clip



Document proof, swiss made - x-20 Jogger refill, writing length: approx. 2.000 m

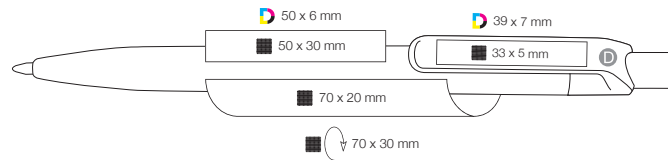

INSIDER ST 02310



Solid white barrel and pusher, transparent clip



Document proof, swiss made - x-20 Jogger refill, writing length: approx. 2.000 m

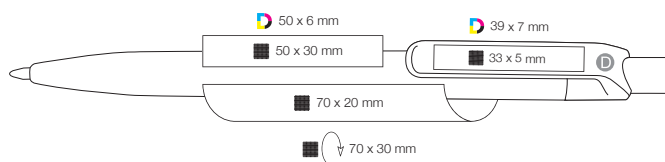

INSIDER TRANSPARENT 12300

Made in Germany



Transparent barrel with prism optics



Document proof, swiss made - Jumbo Marathon refill,
writing length: approx. 2.500 m

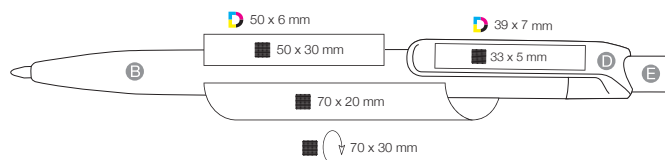

INSIDER TRANSPARENT M 12302

Made in Germany



Transparent barrel with prism optics
metalized pusher



Document proof, swiss made - Jumbo Marathon refill,
writing length: approx. 2.500 m

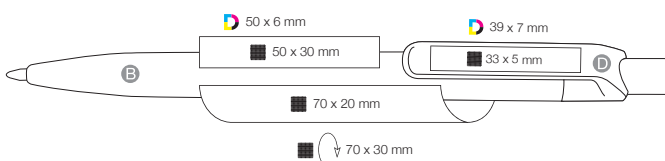

RETRO

CLASSIC

TWISTER FROZEN 00041

Made in Germany

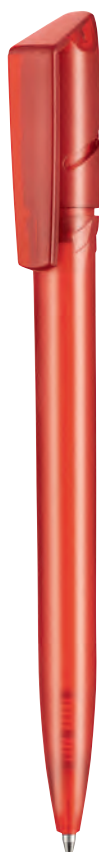

Marathon



Twist mechanism, frosted colors



Document proof, swiss made - Jumbo Marathon refill, writing length: approx. 2.500 m



TWISTER 00040

Made in Germany

! Twist mechanism, matt surface and shiny clip

Document proof, swiss made - x-20 Jogger refill, writing length: approx. 2.000 m

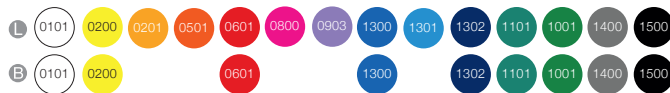
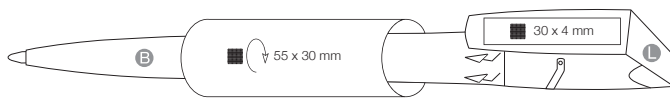

BUBBLE TRANSPARENT 14400

Made in Germany

! Comfortable soft grip, produced in high quality two-material injection

Document proof, swiss made - Jumbo Marathon refill, writing length: approx. 2.500 m

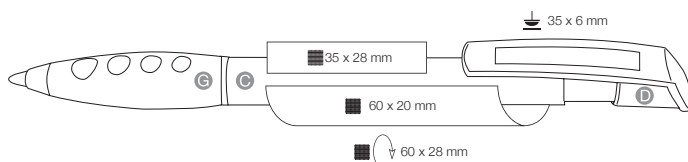



Jogger



Comfortable soft grip, produced in high quality two-material injection



Document proof, swiss made - x-20 Jogger refill, writing length: approx. 2.000 m

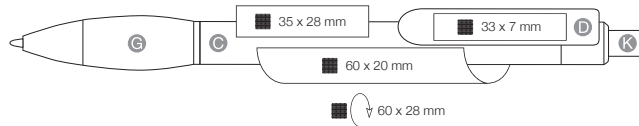

DIVA TRANSPARENT 18198



Marathon



Comfortable soft grip, produced in high quality two-material injection



Document proof, swiss made - Jumbo Marathon refill, writing length: approx. 2.500 m

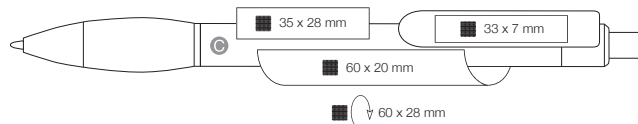

! Chrome-platted cap with shiny metal parts

Document proof, swiss made - large capacity Ultra refill, writing length: approx. 6.000 m

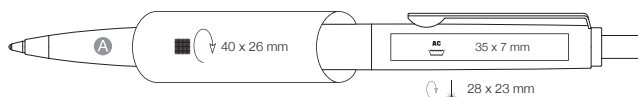

SATELLITE 07110

! Soft pusher, desgin metal clip

Document proof, swiss made - x-20 Jogger refill, writing length: approx. 2.000 m

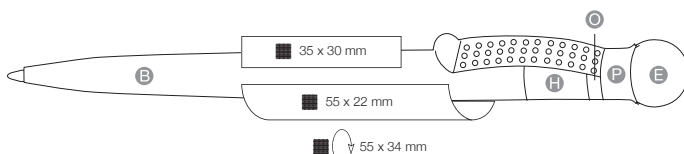

Jogger

NEW BASIC 19300

Made in Germany



! Shiny surface, big variety of solid colours for mix & match

Document proof, swiss made - x-20 Jogger refill, writing length: approx. 2.000 m

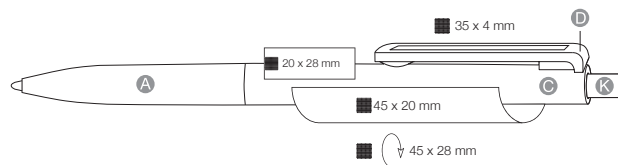

BASIC 19414

Made in Germany



! Shiny surface, big variety of solid colours for mix & match

Document proof, swiss made - x-20 Jogger refill, writing length: approx. 2.000 m

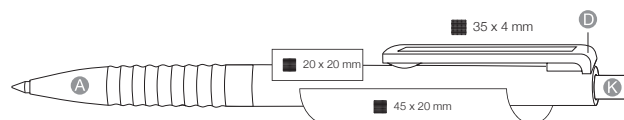

CLASSIC 01711

Made in Germany

! Shiny surface, solid colors, metal clip, pusher, ring and tip



Document proof, swiss made - x-20 Jogger refill, writing length: approx. 2.000 m

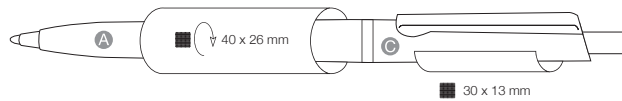

CLASSIC TRANSPARENT 11711

Made in Germany

! Transparent colors, metal clip, pusher, ring and tip



Document proof, swiss made - x-20 Jogger refill, writing length: approx. 2.000 m

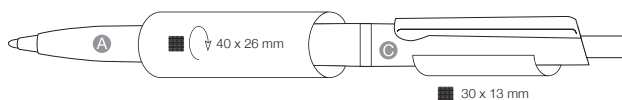

Marathon

PIN PEN



DAILY HELPER

PIN PEN 00060

Made in Germany



Jogger



Magnetic pin, flexible metal chain



Document proof, swiss made - x-20 Jogger refill, writing length: approx. 2.000 m

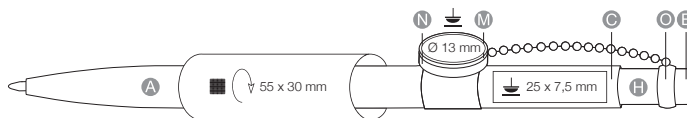

- ! Individual shape for pin available from 3.000 pcs.
- ! Magnetic pin, flexible metal chain
-  Document proof, swiss made - x-20 Jogger refill, writing length: approx. 2.000 m

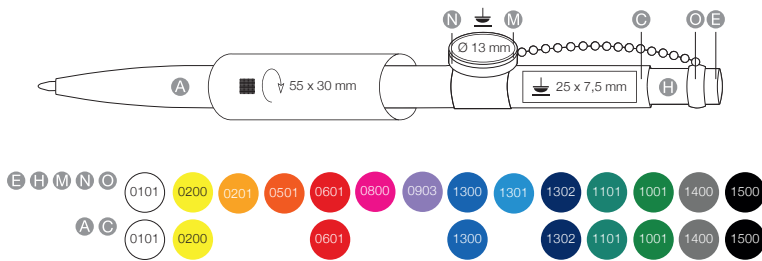

COMBI 20124

- ! Retractable ball pen with additional function: Soft rubber cap for smartphone, tablets and computer touch screens
-  Blue writing, Budget large capacity refill, writing length: approx. 1.200 m

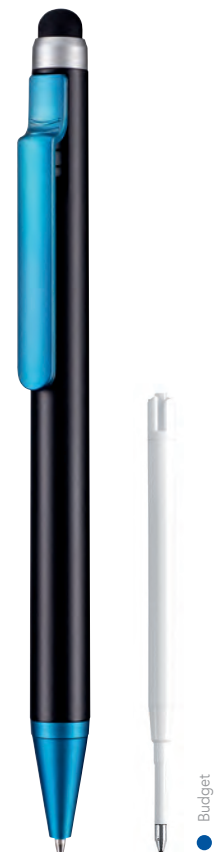
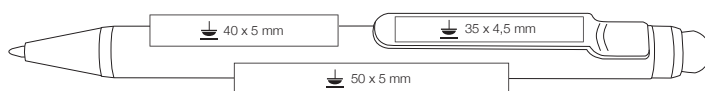

SPRING



TIME TESTED

SPRING GRIPPY 08138

Made in Germany



Jogger



Flexible, durable spring clip, comfortable soft grip, produced in high quality two-material injection



Document proof, swiss made - x-20 Jogger refill, writing length: approx. 2.000 m

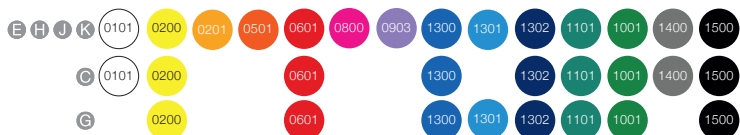
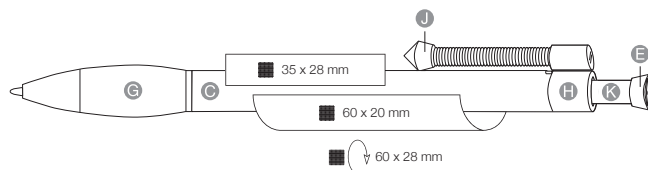

SPRING 08032

Made in Germany



Flexible, durable spring clip



Document proof, swiss made - x-20 Jogger refill, writing length: approx. 2.000 m

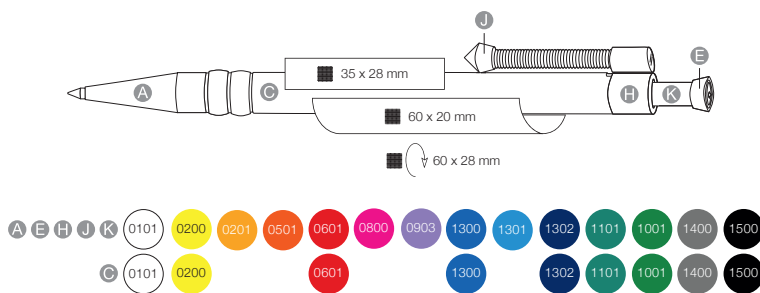

SPRING SP 08036

Made in Germany



Flexible, durable spring clip



Document proof, swiss made - x-20 Jogger refill, writing length: approx. 2.000 m

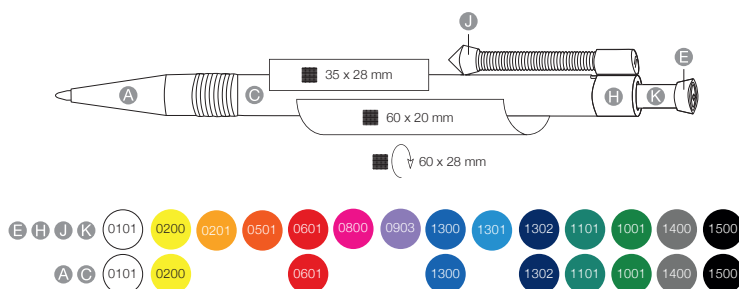

STRONG 08200

Made in Germany



Marathon



Flexible, durable spring clip



Document proof, swiss made - Jumbo Marathon refill, writing length: approx. 2.500 m

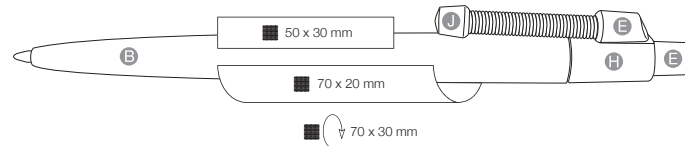

STRONG TRANSPARENT 18200

Made in Germany



Marathon



Flexible, durable spring clip, transparent colors



Document proof, swiss made - Jumbo Marathon refill, writing length: approx. 2.500 m

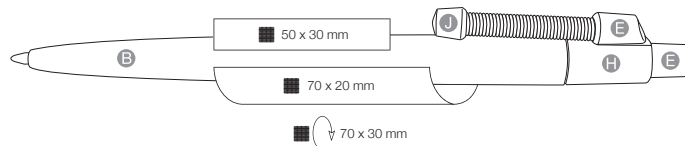

#80pagesdone
#takeabreak



FOIL



HIGH DEFINITION

STRATOS CAMOUFLAGE 47910

Made in Germany



Ultra



Camouflage design



Document proof, swiss made - large capacity Ultra refill,
writing length: approx. 6.000 m



NEW
2021



STRATOS TRANSPARENT FOIL P 57910

Made in Germany

! HD-Foil, available from 5.000 pcs., approx. production time 9-10 weeks

Document proof, swiss made - large capacity Ultra refill, writing length: approx. 6.000 m

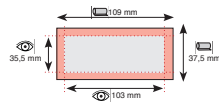
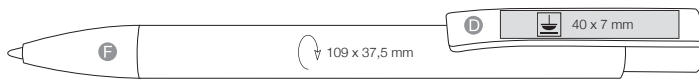

EXOS FOIL 57600

Made in Germany

! HD-Foil, available from 5.000 pcs., approx. production time 9-10 weeks

Document proof, swiss made - large capacity Ultra refill, writing length: approx. 6.000 m

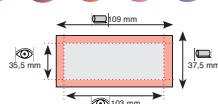
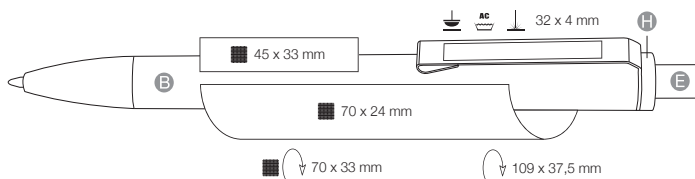

DIVA FOIL 58198

Made in Germany



Marathon



HD-Foil, available from 5.000 pcs.,
approx. production time 9-10 weeks



Document proof, swiss made - Jumbo Marathon refill,
writing length: approx. 2.500 m

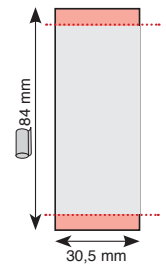

BUBBLE FOIL 54400

Made in Germany



Marathon



HD-Foil, available from 5.000 pcs.,
approx. production time 9-10 weeks



Document proof, swiss made - Jumbo Marathon refill,
writing length: approx. 2.500 m

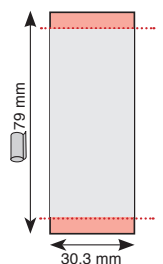
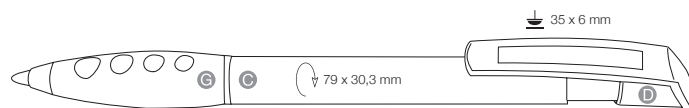

BOOSTER TRANSPARENT FOIL 42773

Made in Germany

! Digital-Foil, available from 500 pcs.

Document proof, swiss made - Jumbo Marathon refill,
writing length: approx. 2.500 m

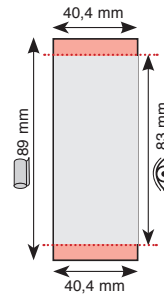

Marathon



UNLIMITED POSSIBILITIES



ON STOCK

HAVANA 00118

Ritter Global



! Twist mechanism, shiny surface, metal clip and tip

Large capacity Budget refill, writing length: approx 1.200 m

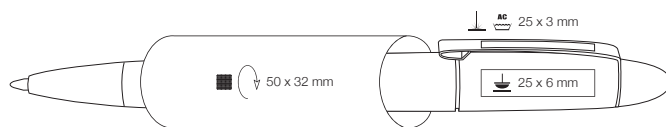

HAVANA TRANSPARENT 10118

- ! Twist mechanism, transparent colors, metal clip and tip
- Refill 100% Large capacity Budget refill, writing length: approx 1.200 m

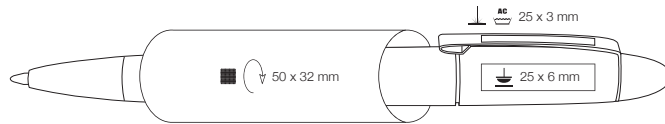

GLOSSY 00086

- ! Twist mechanism, shiny surface, metal clip and tip
- Refill 100% Large capacity Budget refill, writing length: approx 1.200 m



GLOSSY TRANSPARENT 10086



Twist mechanism, transparent colors, metal clip and tip



Large capacity Budget refill, writing length: approx 1.200 m

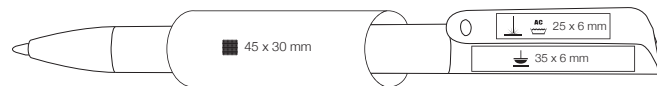

GLORY TRANSPARENT 10123



Twist mechanism, transparent colors, metal tip



Blue, large capacity Budget refill, writing length: approx 1.200 m

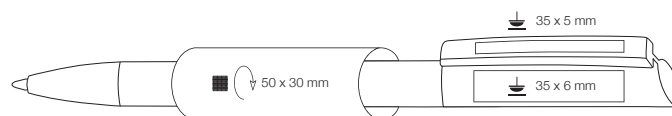

GLORY 00123

! Twist mechanism, shiny surface, solid colors

Blue, large capacity Budget refill,
writing length: approx 1.200 m

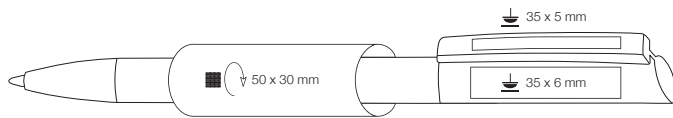

TRIGGER 00127

! Shiny surface, solid white barrel, colored clip
also available in completely black

Blue, large capacity Budget refill,
writing length: approx 1.200 m

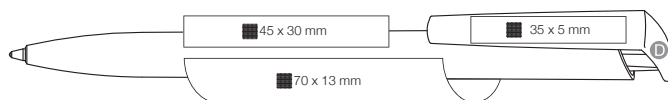



! Transparent colors

Blue, large capacity Budget refill,
writing length: approx. 1.200 m

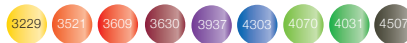
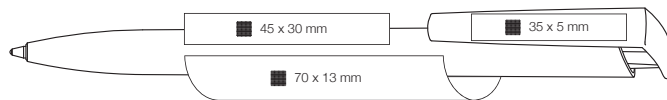

IONOS TRANSPARENT 41280



! Silver lacquered clip and pusher, transparent barrel

Blue, large capacity Budget refill,
writing length: approx. 1.200 m

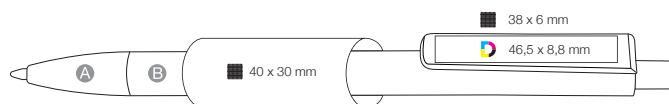

IONOS SOFT 01281

! Soft touch surface

Blue, large capacity Budget refill,
writing length: approx. 1.200 m



IONOS 31280

! Silver lacquered clip, tip and pusher,
transparent barrel

Blue, large capacity Budget refill,
writing length: approx. 1.200 m

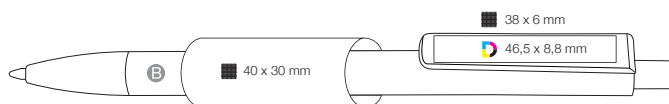



Budget



Twist mechanism, frozen colors, silver lacquered tip



Large capacity Budget refill, writing length: approx. 1.200 m

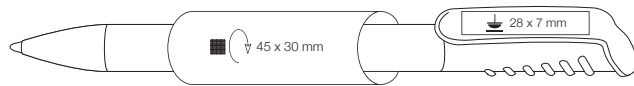

Budget



Twist mechanism, frozen colors, silver lacquered tip and clip



Blue, large capacity Budget refill, writing length: approx. 1.200 m



FLIP SILVER 50121

! Twist mechanism, silver lacquered

Refill 100% Blue, large capacity Budget refill, writing length: approx. 1.200 m

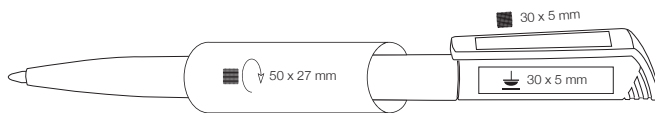

FLIP TRANSPARENT 30121

! Twist mechanism, transparent colors

Refill 100% Blue, large capacity Budget refill, writing length: approx. 1.200 m

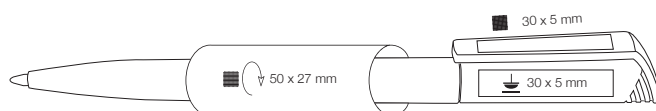



! Twist mechanism, shiny surface

Refill 100% Blue, large capacity Budget refill, writing length: approx. 1.200 m

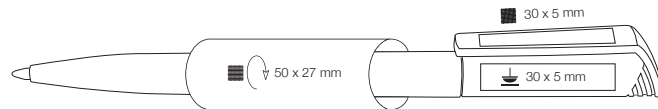

CETUS TRANSPARENT 10109



! Grip area, frosted colors, silver lacquered clip

Refill 100% Blue, large capacity Budget refill, writing length: approx. 1.200 m

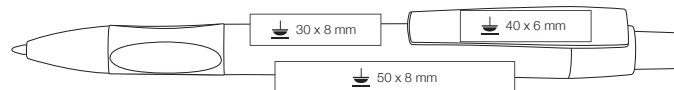

- ! Frosted soft grip, shiny white barrel and tip, transparent pusher
- Blue, large capacity Budget refill, writing length: approx. 1.200 m

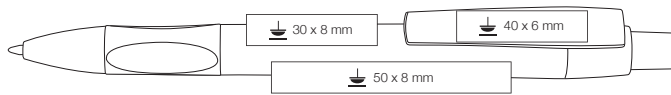

CETUS SILVER 30119

- ! Frosted soft grip, silver lacquered
- Blue, large capacity Budget refill, writing length: approx. 1.200 m

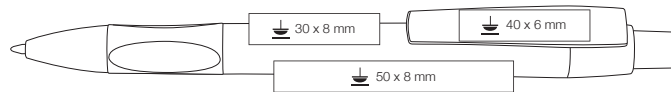



EXCLUSIVE

TRITON 61310/-20

Ritter Global



Heavy, high-quality metal ball pen with twist mechanism, black and white lacquered housing, applications matt silver plated, spring-mounted, solid metal clip, incl. pen-box



Document proof, swiss made - large capacity Ultra Metal refill, writing length: approx. 8.500 m



Ultra Metal



brilliant GRAVUR

RITTER PEN PREMIUM

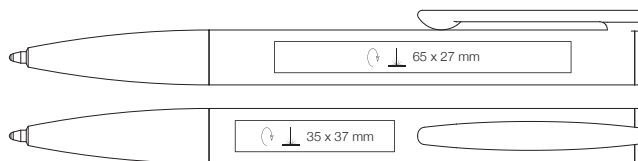

61320 White

FORTUNA ROLLERBALL 61000.03

! High-quality metal ball pen with twist mechanism, black or white lacquered housing, applications silver plated, incl. pen-box

100% Document Proof Swiss made - Roller refill 0,7mm, writing length: approx. 750 m

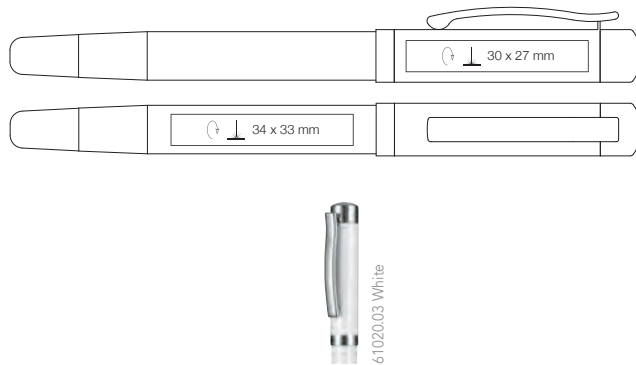

brilliantGRAVUR
RITTER PEN
PREMIUM



Roller

FORTUNA 61000

! High-quality metal ball pen with twist mechanism and black or white lacquered housing, applications silver plated, incl. pen-box

100% Document Proof Document proof, swiss made - large capacity Ultra Metal refill, writing length: approx. 8.500 m

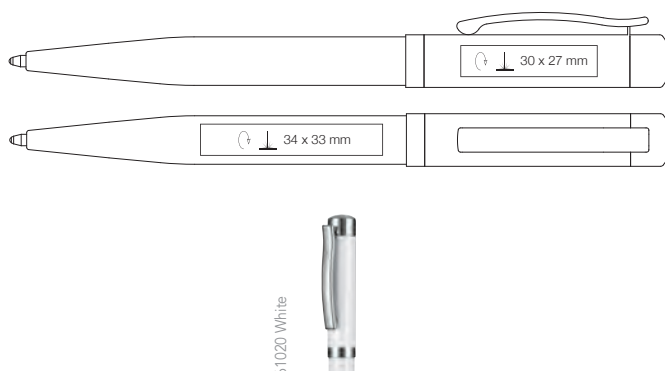

brilliantGRAVUR
RITTER PEN
PREMIUM



Ultra Metal



Ultra Metal
 • *brillant*GRAVUR
 • **RITTERPEN**
PREMIUM



High-quality metal ball pen with twist mechanism, black lacquered housing, applications silver plated, incl. pen-box



Document proof, swiss made - large capacity Ultra Metal refill, writing length: approx. 8.500 m

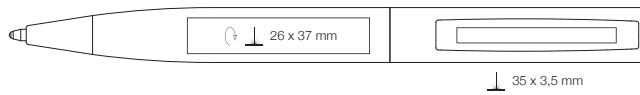

FORTUNA SET 61000/-20



High-quality metal ball pen with twist mechanism, black or white lacquered housing, applications silver plated, incl. pen-box



Document proof, swiss made - large capacity Ultra Metal refill, writing length: approx. 8.500 m
 swiss made - Roller refill 0,7mm, writing length: approx. 750 m

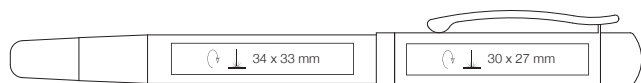



HIGH VALUE

NOBLE 61200

Ritter Global



Metal ball pen with twist mechanism, lacquered housing, polished applications



Large capacity budget blue metal refill writing length: approx. 3.500 m

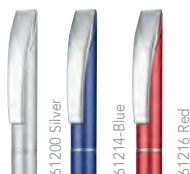
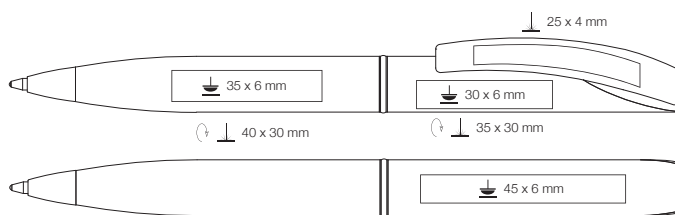

61200 Silver

61214-Blue

61216 Red



Budget



Roller-Mine



Rollerball with cap, matt silver or black, polished applications, incl. pen-box



Swiss made - Roller refill 0,7 mm, writing length: approx. 750 m

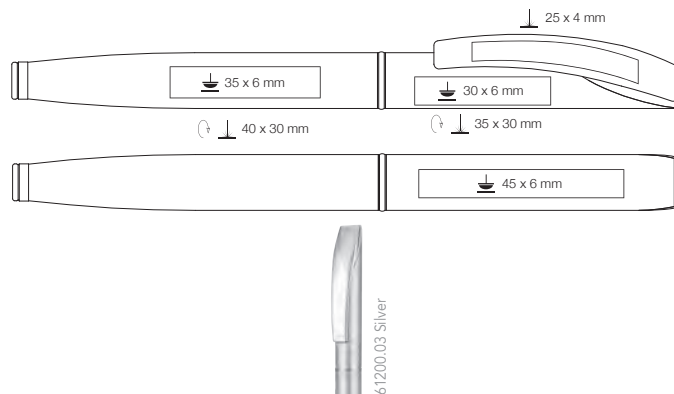

61200.03 Silver

NOBLE SET 61200



Metal ball pen with twist mechanism and rollerball with cap in set of 2, silver or black lacquered housing, incl. pen-box



Document proof, swiss made - large capacity Ultra Metal refill, writing length: approx. 8.500 m

swiss made - Roller refill 0,7mm, writing length: approx. 750 m

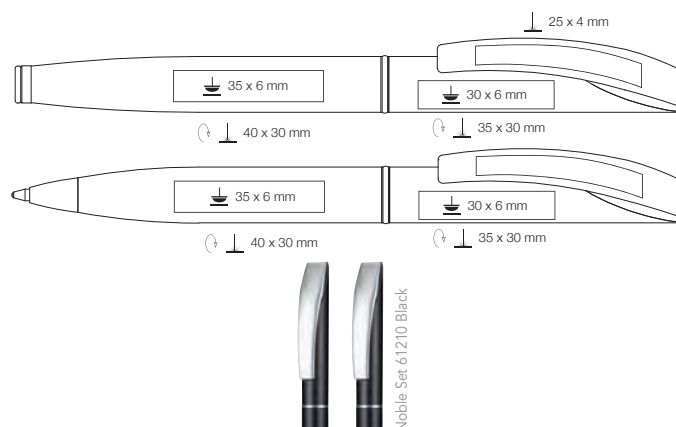

Noble Set 61210 Black



Metal ball pen with push mechanism, lacquered barrel, clip and tip in black



Large capacity budget blue metal refill writing length: approx. 3.500 m

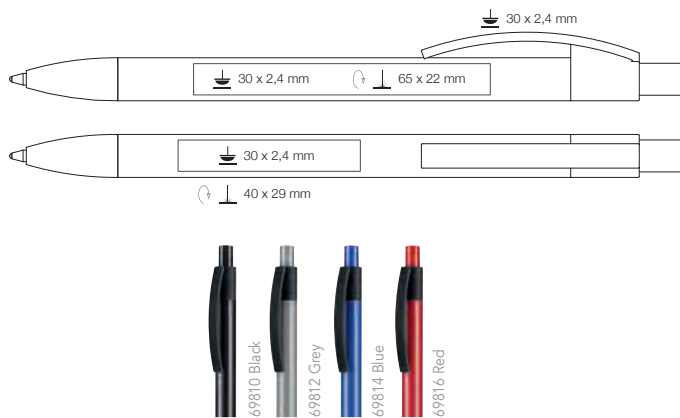

CAPRI SOFT 69910



Metal ball pen with push mechanism, soft touch finish for a perfect feel



Large capacity budget blue metal refill writing length: approx. 3.500 m

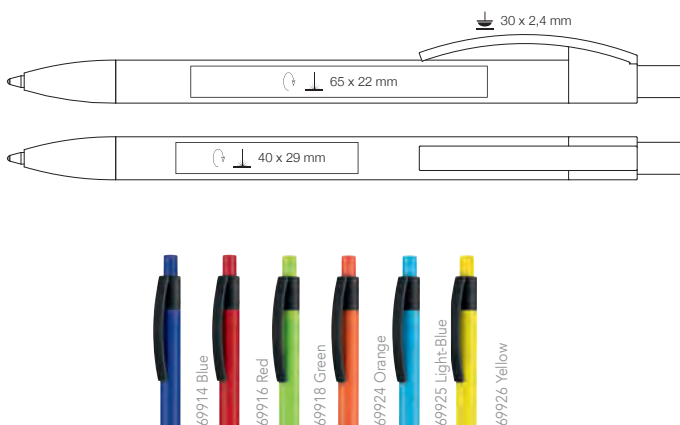



● Budget



Metal ball pen with push mechanism, chrome barrel, polished applications



Large capacity budget blue refill
writing length: approx. 1.200 m

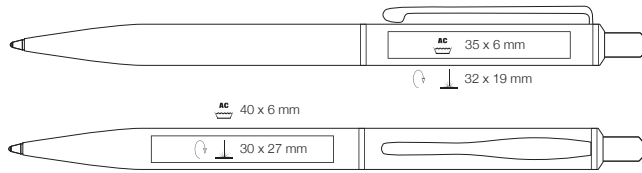

GLANCE 68700



● Budget



Metal ball pen with push mechanism, anodized barrel, polished applications



Large capacity budget blue refill
writing length: approx. 1.200 m

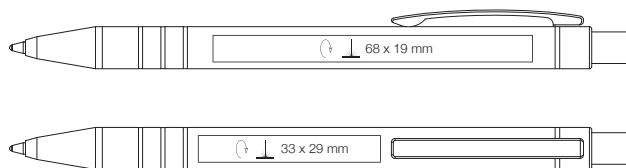

TOUCHPEN 67500



Compact metal twist ball pen with additional function: Soft rubber cap for operating smartphones, tablet PCs, available in 4 different colors



Budget slim refill, writing length: approx. 300 m

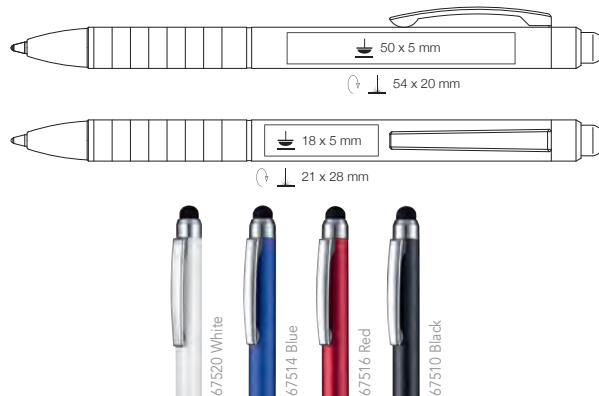

STEEL 68000



Slim metal ball pen with push mechanism, stainless steel barrel, polished applications



Large capacity budget blue metal refill writing length: approx. 3.500 m

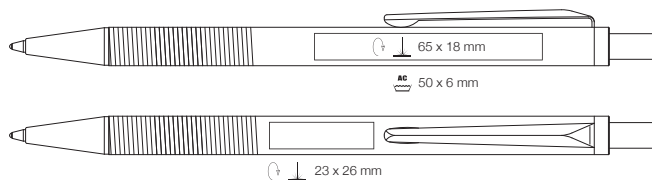



Metal ball pen with push mechanism, lacquered, aluminum barrel in ergonomic square design, black applications



Large capacity budget blue metal refill writing length: approx. 3.500 m

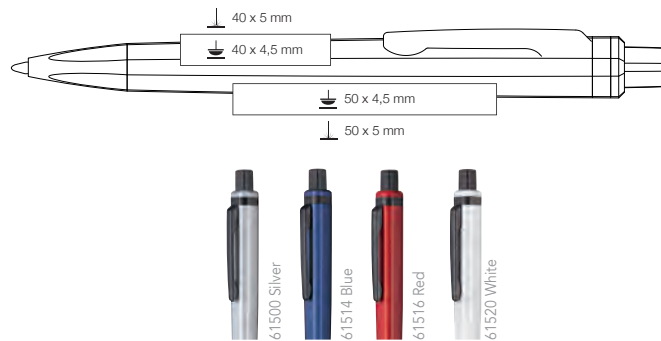

COMBI METALL 60124



Metal retractable ball pen with additional function: soft rubber cap for operating smartphones, tablet PCs, lacquered barrel with black applications



Large capacity budget blue metal refill writing length: approx. 3.500 m

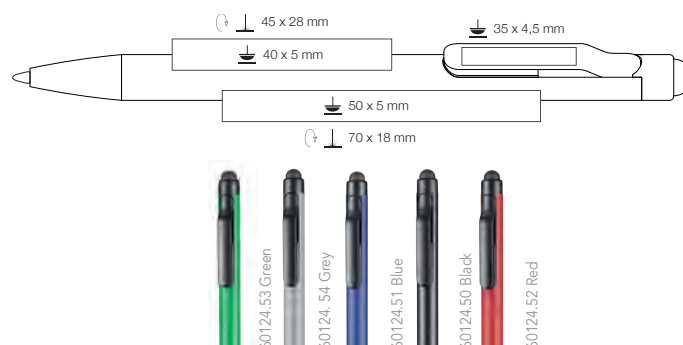

TRIANGLE 68900



Metal ball pen with push mechanism, aluminium barrel, lacquered, in ergonomic triangular shape



Large capacity budget blue metal refill writing length: approx 3.500 m

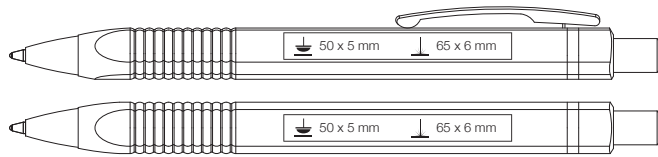

TRIANGLE SET 68900



Metal ball pen with push mechanism, as a set of 2 with a mechanical pencil in a metal pen box, aluminium barrel, lacquered, in ergonomic triangular shape



Large capacity budget blue metal refill writing length: approx. 3.500 m
0.5 mm pencil mechanism

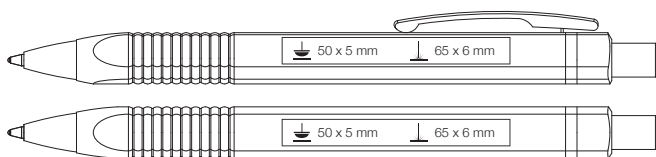

NOTES TO GO

REMEMBER ME

NOTES TO GO⁺ 69.7634

Ritter Global

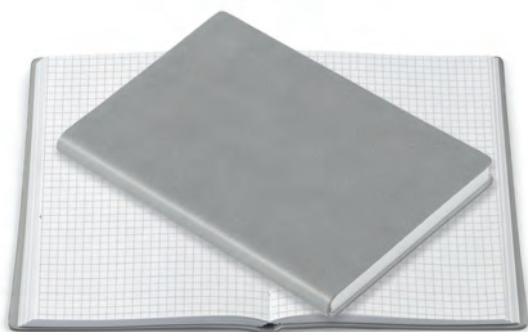

Practical, compact notebook with a gray soft touch cover



Perfect pocket size , 80 sheets, white graph paper with perforation, handy size (9.5 x 14cm)



Blind embossing on the cover in dark gray look

NOTES TO GO 365 69.7633

- ! Practical annual calendar
- ! Perfect pocket size , 80 sheets, white graph paper with perforation, handy size (9.5 x 14cm)
- ! Blind embossing on the cover in dark gray look
- ! Min. quantity 5.000 pcs.



NOTES TO GO 69.7605

- ! Practical, compact notebook with a black soft touch cover
- ! Handy pocket size (9.5 x 14cm)
- ! 48 sheets, black cover



! Practical, compact notebook with a white soft touch cover

! Handy pocket size (9.5 x 14cm), 48 sheets



NOTES TO GO 69.7604

! Practical, compact notebook with 32 sheets, natural cover with thread binding

! Handy pocket size (9.5 x 14cm), 48 sheets



- ! Mini highlighter in 4 different colors, size approx. 7 cm

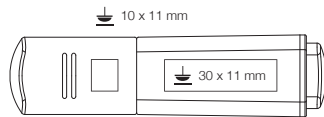

MINISSIMO SET 20010-06

- ! Available as a set: 3 colors, including white plastic base and transparent slipcase

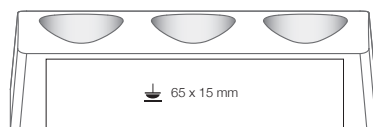



WHY POLY BAGS?

What is the reason for using poly bags ?

Almost all Ritter pens are packed in polyethylene bags. This type of packaging offers many advantages, especially in terms of sustainability, e.g. compared to paper or cardboard packaging:

Polyethylene (PE) is a very tear-resistant plastic that we use to keep our pens safe and protected. The tensile strength ensures that the packaging is tightly bundled so that the pens are “fixed” to avoid scratches.

PE is a thermoplastic and can be recycled. It consists of 100% carbon and hydrogen and burns to carbon dioxide and water. Polyethylene does NOT contain any plasticizers.

The production of PE does not produce any toxic gases or toxic waste water - even food is packed in polyethylene. Compared to paper, PE can be produced with very low thicknesses, so that approx. 5-7 times less material is used than for paper products.

PACKAGING



56.4155
Pen-Box for 1 pen

56.4154
Pen-Box for 2 pens



56.7018.1541.6009
Paper-Stick-Box



56.6101
Metal-Box

56.6102
Metal-Box for 2 pens



56.7018.1541
Paper-Stick-Box



56.4133
Acryl-Tube with plastic plugs



56.7039
Paper-Stick-Box, recycled paper

ATTENTION: Please consider that not every pen model fits in all available boxes! On request!

SALES SUPPORT



PEN PRESENTATION

This semi-transparent plastic folder contains original pens along with virtual concepts using your client's logo. Leave no questions unanswered with this professional presentation designed to your customers specifications.

Dimensions: 50 x 315 x 275 mm

REFILL-BOX Art. Nr. 69.9127

Sample box with a selection of different refills. For the presentation and testing of the most common RITTER-PEN standard and soft refills.

Dimensions: 17 x 17,5 x 2,0 cm



PROMOTION BOX

The new sample box from RITTER PEN, suitable for 5 pens, optionally with display stand („frame“) for presentation in a showroom. The sample box always consists of a tray and a fitting slipcase. The tray is made from the innovative material REINPAPIER, made from recycled bio-based paper. The box is available for different models.

Dimensions without frame: 17 x 17.5 x 2.0cm

Dimensions including frame 19.5 x 19.5 x 2,5 cm

3D-BOX ECO-LINE 69.9113

Cardboard sample kit for 24 pens of the ECO-LINE. With carrying handle.

Dimensions: 245 x 229 x 57 mm





DISPLAYSTAND

The eye-catcher in your showroom.
3-sided cardboard floor display with sturdy, rotatable stand holds 81 writing instruments divided into 27 groups of three. So a total of 27 models are presented.
The eye-catcher in your showroom.

Dimensions: 1800 x 470 x 470 mm



PENROLE Art. Nr. 69.9020

Practical sample presentation, easy to use, offers space for 40 writing instruments, divided into 8 groups of 5 ballpoint pens. Can be rolled up to a compact size with a Velcro fastener.



COLOR CHIPS Art. Nr. 69.0010

Color samples of ABS plastic with embossed reference numbers. A perfect everyday tool.

WOODEN DISPLAY RITTER CARES Art. Nr. 69009

The perfect presentation for the RITTER CARES series. Wooden display with holders for a total of 30 writing instruments.

Dimensions: 42 x 52 x 25 cm



Refills

Pen refills at RITTER PEN

Depending on the price segment, we offer different standard refills for our pens. Even inexpensive budget refills meet the highest demands! The writing experience is perfect with the new BALANCE FLOW refill system, which will be used in all writing instruments manufactured in Germany:

RITTER-BALANCE FLOW

High-tech, Swiss made refills are used for all ball pens manufactured in Germany. These correspond to the strict Swiss standard, are waterproof and ISO 12757-2 certified. Balance Flow is a fundamental aspect when aligning a refill system for the perfect writing experience. Ritter Pen's BALANCE FLOW refill system is the point of intersection between a soft writing feeling and an optimum writing length with consistent quality. BALANCE FLOW is available for Jogger, Marathon and Ultra with 1,0 ball. Soft refills with 1,2 mm also available for the lovers of soft, rich writing.

JOGGER-Refill

The most commonly purchased refill in the advertising industry. A million-seller. Perfect writing characteristics and a highly acceptable writing length.

Jogger

ca. 2.000 m*
Tip brass nickel-plated, 1.0 mm TC-ball
ISO 12757-2 / document proof

Jogger Soft

ca. 1.400 m*
Tip brass nickel-plated, 1.2 mm TC-ball
ISO 12757-2 / document proof



MARATHON-Refill

The big sister of the JOGGER refill. With a slightly thicker refill tube, it conveys a touch of exclusivity in addition to the 25% longer writing length.

Marathon

ca. 2.500 m*
Tip brass nickel-plated, 1.0 mm TC-ball
ISO 12757-2 / document proof

Marathon Soft

ca. 1.800 m*
Tip brass nickel-plated, 1.2 mm TC-ball
ISO 12757-2 / document proof



ULTRA-Refill

This refill is a must for anyone who is interested in great value. A large-capacity refill that lives up to its name. Perfect writing characteristics and a writing length three times as long as a conventional x-20 refill quickly get writers' attention. A refill for image building.

Ultra

ca. 6.000 m*
Tip Stainless steel, 1.0 mm TC-ball
ISO 12757-2 / document proof

Ultra Soft

ca. 4.000 m*
Tip Stainless steel, 1.2 mm TC-ball
ISO 12757-2 / document proof



Writing length is not exactly measurable, because of many criterions e. g. tolerances in TC-ball, ball bearing, ink paste, thus different ink flow, quality of paper, writing pressure, climate, TC-ball size, etc. The standard refill for every pen you can find on the according page in catalogue for every model. The additional cost for refill upgrade please find in your pricelist.

ULTRA METAL-Refill

The undisputed superstar among the refills. High-tech processing at its finest. Ultimate writing length and shelf life. Its metallic weight conveys its high quality. A refill for people who don't want to compromise on quality.

Ultra Metal _____
 ca. 8.500 m*
 Tip Stainless steel, 1.0 mm TC-ball
 ISO 12757-2 / document proof



Ultra Metal Soft _____
 ca. 5.000 m*
 Tip Stainless steel, 1.2 mm TC-ball
 ISO 12757-2 / document proof



ULTA SUPER SOFT-Refill

The Ultra refill is now also available in the Super Soft version with a 1.4 mm ball for an even softer, richer writing feel.

Ultra Super Soft _____
 ca. 3.400 m*
 Tip Stainless steel, 1.4 mm TC-ball
 ISO 12757-2 / document proof



ULTRA RECYCLED-Refill

The sustainable variant of the Ultra Mine. The lead tube and stopper are made of 95% recycled polypropylene. In Combined with the writing performance of up to 6,000m, a sustainable upgrade for every RITTER PEN.

Ultra Recycled PP _____
 ca. 6.000 m*
 Tip Stainless steel, 1.0 mm TC-ball
 ISO 12757-2 / document proof



GEL-Refill

The only wet writing refill with near roller characteristics. A more fluid writing feeling is almost impossible. A refill for absolute enthusiasts.

Gel _____
 ca. 600 m*
 Tip Stainless steel, 0,7 mm TC-ball
 ISO 27668



Mechanical Pencil _____
 DSM 0,5 mm



Mechanical Pencil _____
 x-20 0,5 mm



Stylus / Touch Mine _____



Budget _____
 ca. 1200 m*
 ISO 12757-1
 Ritter Global



Budget Metal _____
 ca. 3500 m*
 ISO 12757-1
 Ritter Global



Budget Slim _____
 ca. 300 m*
 ISO 12757-1
 Ritter Global



INFORMATION REGARDING THE DIFFERENT METHODS OF ADVERTISING

SCREEN-PRINTING

The required film for screen printing must be applied in the correct direction, for BASIC & VOLUMES color prints with register crosses. Colors will be printed according to your color specifications (Pantone, HKS, RAL). Please consider the following for halftone prints: Screen is halftone 40 (40 lines per centimeter), Halftone is between 20% and 80%

- Despite the optimal matching of all imprinted components, imprints on metal pens are only partially scratch resistant.

PAD-PRINTING

The film must be side inverted. Color specifications (Pantone, HKS, RAL) are required. Please consider the following for halftone prints: Screen is halftone 48, (48 lines per centimeter), Halftone is between 20% and 80%.

- Minimum line thickness for films (screen- and pad imprint) is +0,15 mm and -0,3 mm.
- Regarding screen- and pad-prints according to color specifications (Pantone, HKS or RAL) on colored barrels, please consider that it might be necessary to print white background (i.e. one additional printing color)
- Despite the optimal matching of all imprinted components, imprints on metal pens are only partially scratch resistant.

ETCHING

The required film for screen printing must be applied in the correct direction. The etching on the surface will appear grey/brown depending of the coloration on the underlying material. Variations within one production is possible. Please note that for every 2000 pcs. etchings, we require one film (e.g. for 10,000 pcs. etchings, 5 films are required).

- Please note: Maximum line thickness of texts and logos is 1.2 mm.

LASER ENGRAVING

For laser engraving we need high resolved files (look at „FILES“)

DIGITAL-FOIL

An image is transported on a carrier film. This film is then applied to the barrel of the ballpoint pen using a hot stamping process. The data for creating the slide images should be high-resolution and in CMYK.

- When creating the data, please note the required size for the respective model. For foiling, 3 mm trim is required on the right and left.

HD-FOIL

An image is transported on a carrier film. This process ensures perfect image and adhesive quality. Due to the tooling cost, the minimum quantity is 5,000 pieces.

DIGITAL-PRINTING

In this procedure, the logo is printed directly on the ballpoint pen. Digital printing is particularly suitable for multi-color logos and color gradients. The colors are converted into CMYK and therefore can differ slightly from the Pantone datas.

FILES

Please provide:

- Vectorfiles: Illustrator CC2015, included texts have to be converted into text paths, in order to avoid problems with the fonts.
- Pixelfiles: Photoshop CS6 (600 dpi min.). The logo size must be 1:1 or larger.

**„Give them quality, that is
the best kind of advertising.“**

Milton Hershey